

FREZZA[®]

pop

pop

design R&D Frezza

FREZZA[®]

CULTURE AT WORK

In molti luoghi di lavoro si parla di cultura organizzativa, la quale definisce e caratterizza le qualità di un ambiente di lavoro. La cultura è dunque un potente elemento che plasma il luogo di lavoro, il modo di lavorare, le relazioni interpersonali e i processi organizzativi.

In many workplaces we talk about organisational culture, which defines and characterises the qualities of a working environment. Culture is therefore a powerful element that shapes the workplace, the way of working, interpersonal relations and organisational processes.

Dans de nombreuses entreprises, nous parlons de culture organisationnelle, qui définit et caractérise les qualités d'un environnement de travail. La culture est donc un élément puissant qui façonne le lieu de travail, la manière de travailler, les relations interpersonnelles et les processus organisationnels.

POP

office

p. 7



dynamic work

p. 43



meeting

p. 57



organized workspace

p. 71



break out

p. 95



welcome

p. 111



home

p. 119



POP

ace



woody



easy

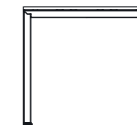

square

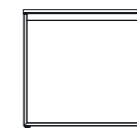

ad

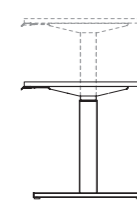

folding



tee



panel

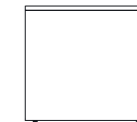

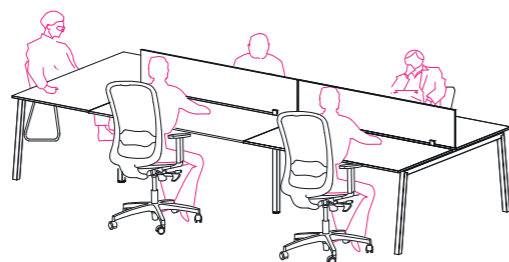
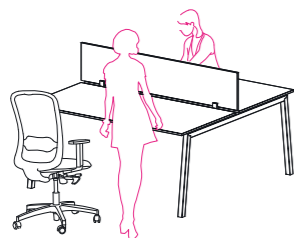

office

L'UFFICIO MODERNO DEVE SAPER RISPONDERE ALLE RICHIESTE DI MAGGIORE FLESSIBILITÀ E CONDIVISIONE. L'OBIETTIVO È TROVARE UN EQUILIBRIO TRA SPAZIO DI LAVORO PRIVATO E SPAZIO DESTINATO ALL'INCONTRO E ALLO SCAMBIO DI INFORMAZIONI. IL DESIGN POP SI FONDE PERFETTAMENTE CON QUALSIASI AMBIENTE.

THE MODERN OFFICE MUST BE ABLE TO MEET THE DEMANDS FOR INCREASED FLEXIBILITY AND SHARING. THE AIM IS TO FIND A BALANCE BETWEEN PRIVATE WORKING SPACES AND SPACES DESTINED FOR MEETING AND EXCHANGING INFORMATION. THE POP DESIGN SEAMLESSLY BLENDS WITH ANY INTERIOR.

LE BUREAU MODERNE DOIT POUVOIR RÉPONDRE AUX DEMANDES DE FLEXIBILITÉ ET DE PARTAGE ACCRUES. L'OBJECTIF EST DE TROUVER UN ÉQUILIBRE ENTRE ESPACE PRIVÉ ET ESPACE DE RÉUNION ET D'ÉCHANGE D'INFORMATIONS. LE DESIGN POP S'INTÈGRE PARFAITEMENT À TOUS LES INTÉRIEURS.



POP WOODY

Scrivania e tavoli bench con struttura in metallo verniciato nero (RAL 9005) e gamba in frassino naturale verniciato trasparente.
Piano in melaminico bianco.

Desk and bench desks with black metal structure (RAL 9005) and leg in natural ash, clear varnished.
White melamine top.

Bureau et bureaux doubles avec structure métallique noire (RAL 9005) et piétement en frêne naturel verni transparent.
Plateau en mélamine blanche.

CLASSE 6 - EM60

Seduta operativa / Task chair /
Siège bureau
Remix 3 - RIRB

YO STOOL

Design: Giacobone + Roj
Progetto CMR
Go Check - T9R5, T9R6



POP WOODY

Il programma di arredo ufficio Pop woody risponde a moderne e molteplici esigenze di lavoro, per momenti individuali di concentrazione o attività collaborative.

Scrivania e bench con mobile di servizio. Gamba in frassino naturale verniciato trasparente e struttura in metallo verniciato nero (RAL 9005). Piano in melaminico bianco.

CLASSE 6 - EM60

Seduta operativa / Task chair / Siège bureau
Remix 3 - RIRB

Pop woody's office furniture program responds to modern and multiple working necessities, from individual activities that require concentration to group ones that require collaboration.

Desk and bench desk with service unit. Black metal structure (RAL 9005) and leg in natural ash, clear varnished. White melamine top.

La collection de mobilier de bureau Pop woody répond aux plusieurs besoins de travail modernes. Concentration individuelle ou activités collaboratives.

Bureau et bureau double avec meuble de service. Structure métallique noire (RAL 9005) avec piétement en frêne naturel verni transparent. Plateau en mélamine blanche.





POP WOODY

Bench 4 posti e tavolo riunioni con gamba in frassino naturale verniciato trasparente e struttura in metallo verniciato bianco (RAL 9010). Piano in melaminico bianco.

4 person bench desk and meeting table with white (RAL 9010) metal structure and leg in natural ash, clear varnished. White melamine top.

Bureau 4 postes et table de réunion avec structure métallique blanche (RAL 9010) et piétement en frêne naturel verni transparent. Plateau en mélamine blanche.

CLASSE 4 - EM 49

Seduta operativa / Task chair / Siège bureau

Rete / Mesh / Résille: Polo - RPG1
Tessuto / Fabric / Tissu:
Jet - JT1R

YO

design Giacobone + Roj Progetto CMR
Seduta multifunzione / Multipurpose chair / Chaise polyvalente

Telaio a 4 gambe / 4-leg frame / Bâti 4 pieds: bianco - white - blanc RAL 9010
Tessuto / Fabric / Tissu: Jet - JT1R



POP WOODY

Pop woody nasce dalla combinazione di una struttura metallica abbinata alla bellezza del legno massello in frassino naturale verniciato trasparente.

Bench 4 posti con gamba in frassino naturale verniciato trasparente e struttura in metallo verniciato bianco (RAL 9010). Piano in melaminico finitura cemento.

LOL

Seduta operativa / Task chair / Siège bureau
Jet - JT07

Pop woody was born from the combination between a metallic structure and beautiful clear-painted natural ash solid wood.

4 person bench desk and meeting table with white (RAL 9010) metal structure and leg in natural ash, clear varnished. Concrete melamine top.

Pop woody est la combinaison d'une structure métallique alliée à la beauté du bois massif en frêne naturel verni transparent.

Bureau 4 postes avec structure métallique blanche (RAL 9010) et piétement en frêne naturel verni transparent. Plateau en mélamine finition béton.



POP ACE

Scrivanie e tavoli alti (H. 105 cm) con struttura in metallo verniciato nero (RAL 9005) e piano in melaminico noce canaletto.

Desks and high tables (H. 105 cm) with black (RAL 9005) metal structure and american walnut melamine top.

Bureaux et tables hautes (Ht. 105 cm) avec structure métallique noire (RAL 9005) et plateau en mélamine finition noyer américain.

LOL

Seduta operativa / Task chair / Siège bureau
Remix 3 - RIGC, RIRB

YO STOOL

design Giacobone + Roj Progetto CMR
Sgabello / Stool / Tabouret
Remix 3 - RIGC, RIRB, RIRG

POP ACE

Scrivania con contenitore.
Struttura in metallo verniciato
nero (RAL 9005) e piano in
melaminico noce canaletto.

Desk with service unit. Black
(RAL 9005) metal structure and
american walnut melamine top.

Bureau avec meuble de service.
Structure métallique noire (RAL
9005) et plateau en mélamine
 finition noyer américain.

LOL

Seduta operativa / Task chair /
Siège bureau
Remix 3 - RIRB



LOL
Seduta operativa / Task chair / Siège bureau
King Flex - XFYD

GUARD SCREEN

In questo periodo di cambiamenti, vengono richieste misure di sicurezza sul posto di lavoro per proteggere la salute delle persone. Per questo motivo, è necessario attuare dei cambiamenti negli ambienti di lavoro studiati sia nel breve che lungo termine.

Guard Screen in melaminico bianco (H. 60 cm).
Guard Screen: schermi rivestiti in tessuto con prolunga in vetro (H. 22 cm).

In these times of change, new safety measures are required to protect and safeguard the health of people in the workplace. For this reason, it's necessary to implement changes in the working environment that are designed for both the short and long term.

Guard Screen in white melamine (H. 60 cm).
Guard Screen: upholstered fabric screen with upper glass (H. 22 cm).

En cette période de changements, de nouvelles mesures de sécurité sont nécessaires pour protéger la santé des personnes sur le lieu de travail. Pour cette raison, il est nécessaire d'activer des changements qui soient conçus à la fois pour le court et le long terme.

Guard Screen in mélamine blanche (Ht. 60 cm).
Guard Screen: panneau écran revêtu en tissu et extension en verre supérieur (Ht. 22 cm).

POP ACE

Bench 4 posti, struttura in metallo verniciato bianco (RAL 9010) e piano in melaminico bianco.

4 person bench desk with white (RAL 9010) metal structure and white melamine top.

Bureau 4 postes avec structure métallique blanche (RAL 9010) et plateau en mélamine blanche.

POP WOODY

Bench 4 posti, struttura in metallo verniciato bianco (RAL 9010) e gamba in frassino naturale verniciato trasparente. Piano in melaminico bianco.

4 person bench desk with white (RAL 9010) metal structure and leg in natural ash, clear varnished. White melamine top.

Bureau 4 postes avec structure métallique blanche (RAL 9010) et piétement en frêne naturel verni transparent. Plateau en mélamine blanche.



POP EASY

Scrivania con allungo laterale. Struttura in metallo verniciato bianco (RAL 9010) e piano in melaminico bianco.

L-shaped desk with white (RAL 9010) metal structure and white melamine top.

Bureau avec retour lateral avec structure en métal blanc (RAL 9010) et plateau en mélamine blanche.

POP SQUARE

Scrivania con mobile di servizio portante. Struttura in metallo verniciato bianco (RAL 9010) e piano in melaminico bianco.

Desk with service unit. White (RAL 9010) metal structure and white melamine top.

Bureau avec meuble de service. Structure métallique blanche (RAL 9010) et plateau en mélamine blanche.

FIOR DI LOTO

design C. Bellini
Seduta multifunzione / Multipurpose chair /
Siège polyvalent
Remix 3 - RIGR





POP EASY
Bench 6 posti con struttura bianca (RAL 9010) e piani in melaminico bianco.

6 person bench desk with white (RAL 9010) metal structure and white melamine tops.

Bureau 6 places avec structure métallique blanche (RAL 9010) et plateaux en mélamine blanche.

FIOR DI LOTO
design C. Bellini
Seduta multifunzione con carter retro schienale in plastica Baydur.
Multipurpose chair with rear side of backrest in Baydur plastic.

Siège polyvalent avec arrière du dossier en plastique Baydur.

Bondai - TBB6



I contenitori sospesi in metallo sono una soluzione di archiviazione particolarmente adatta per postazioni operative di dimensioni ridotte.

Cassetto metallico sospeso con portacasco / portaborse

Porta CPU metallico appeso

Metal hanging filing units are the perfect storage solutions for small sized operative workstations.

Hanging metal drawer with helmet / bag holder

Hanging metal PC holder

Les éléments en métal suspendus sont une solution pour l'archivage particulièrement adaptée aux petits postes de travail.

Tiroir suspendu en métal avec porte casque / sac

Support UC métallique suspendu



Gli schermi divisorii possono essere dotati di una barra attrezzabile che consente l'aggancio di diversi accessori rendendo le postazioni funzionali ed accoglienti.

Porta documenti metallico

The dividing screens can be equipped with a toolbar that allows the attachment of various accessories, allowing the workstation to be functional and tidy.

Metallic document holder



Les panneaux écran peuvent être équipés d'une barre d'outils qui permet de fixer divers accessoires, pour rendre le poste de travail fonctionnel et bien rangé.

Porte-documents en métal

POP EASY

Bench 4 posti con piano terminale per break o meeting informali.
Struttura in metallo verniciato bianco (RAL 9010) con piani in melaminico olmo chiaro.

4 person bench desk with extension table for breaks or informal meeting.
White (RAL 9010) metal structure with light elm melamine tops.

Bureau 4 postes avec plateau d'extrémité pour breaks ou réunions informelles.
Structure métallique blanche (RAL 9010) et plateaux en mélamine elm clair.

EM 46

Seduta operativa / Task chair / Siège bureau
Rete / Mesh / Résille: Polo - RPZ0
Tessuto / Fabric / Tissu: Era - T8R2

KARL

design L. Nichetto
Sgabello / Stool / Tabouret
Era - T8R2





POP SQUARE

Bench 4 posti con struttura in metallo verniciato bianco (RAL 9010) e piani in melaminico bianco.

4 person bench desk with white (RAL 9010) metal structure and white melamine tops.

Bureau 4 postes avec structure métallique blanche (RAL 9010) et plateaux en mélamine blanche.

FIOR DI LOTO

design C. Bellini

Seduta multifunzione con carter retro schienale in plastica Baydur.

Multipurpose chair with rear side of backrest in Baydur plastic.

Siège polyvalent avec arrière du dossier en plastique Baydur.

Bondai - TBV2



flap multipresa: possibilità di accessoriare il piano di lavoro con sistemi multipresa.

multisocket flap: can be added to the desk top.

top accès polyvalent: possibilité d'équiper le plan de travail d'un top accès intégré avec multiprises.

Pannelli di chiusura in melaminico integrati alle strutture della scrivania per garantire una privacy totale.

Melamine closing panels, integrated to the desk's structure, can be added to guarantee total privacy.

Panneaux de fermeture en mélamine intégrés à la structure du bureau pour garantir une privacy totale.

POP EASY

Scrivanie in linea con allungo. Struttura in metallo verniciato bianco (RAL 9010) e piani in melaminico bianco.

Linear desks with return top. White (RAL 9010) metal structure and white melamine tops.

Bureaux en ligne avec retour. Structure métallique blanche (RAL 9010) et plateaux en mélamine blanche.

FIOR DI LOTO

design C. Bellini

Seduta multifunzione con carter retro schienale in plastica Baydur.

Multipurpose chair with rear side of backrest in Baydur plastic.

Siège polyvalent avec arrière du dossier en plastique Baydur.

Bondai - TBV2





POP TEE

Scrivania con gamba a T e cassettera H. scrivania. Struttura in metallo verniciato bianco (RAL 9010) e piano in melaminico bianco.

T-leg desk and desk-height pedestal. White (RAL 9010) metal structure and white melamine top.

Bureau avec piétement de forme T et caisson Ht. bureau. Structure métallique blanche (RAL 9010) et plateau en mélamine blanche.

CLASSE 5 - EM59

Seduta operativa / Task chair / Siège bureau

Bodai - TBGC



Il concetto di funzionalità si esprime in un'unica struttura metallica tecnica ed essenziale.

POP TEE

Scrivania con gamba a T. Schermi divisorii rivestiti in tessuto Bondai - TBB2. Struttura in metallo verniciato bianco (RAL 9010) e piano in melaminico bianco.

CLASSE 5 - EM59

Seduta operativa / Task chair / Siège bureau Bondai - TBB2

The concept of functionality is expressed by a simple technical metal structure.

T-leg desk. Screens upholstered in Bondai - TBB2 fabric. White (RAL 9010) metal structure and white melamine top.

Le concept de fonctionnalité est résumé dans une structure métallique technique unique et essentielle.

Bureau avec piétement de forme T. Panneaux écran revêtus en tissu Bondai - TBB2. Structure métallique blanche (RAL 9010) et plateau en mélamine blanche.



POP TEE

Scrivania con gamba a T e mobile di servizio. Struttura in metallo verniciato bianco (RAL 9010) e piano in melaminico bianco.

T-leg desk with service unit. White (RAL 9010) metal structure and white melamine top.

Bureau avec piétement de forme T et meuble de service. Structure métallique blanche (RAL 9010) et plateau en mélamine blanche.



POP TEE

Scrivanie in linea con mobile di servizio laterale.
Struttura in metallo verniciato nero (RAL 9005) e
piani in melaminico noce canaletto.

Linear desks with lateral service units. Black
(RAL 9005) metal structure and american walnut
melamine tops.

Bureaux en ligne avec meuble de service latéral.
Structure métallique noire (RAL 9005) et plateaux
en mélamine noyer américain.

CLASSE 5 - EM59

Seduta operativa / Task chair / Siège bureau
King Flex - XFYD



POP PANEL

Scrivanie con allungo laterale.
Struttura e piano in melaminico
bianco.

L-shape desks with white
melamine structure and top.

Bureaux avec retour latéral.
Structure et plateau en mélamine
blanche.

POP PANEL

Scrivanie con allungo laterale.
Struttura e piano in melaminico
bianco.

L-shape desks with white
melamine structure and top.

Bureaux avec retour latéral.
Structure et plateau en mélamine
blanche.



POP PANEL

Scrivania con allungo laterale.
Struttura e piano in melaminico
noce canaletto.

L-shape desk with american
walnut melamine structure and
top.

Bureau avec retour latéral.
Structure et plateau en mélamine
noyer américain.

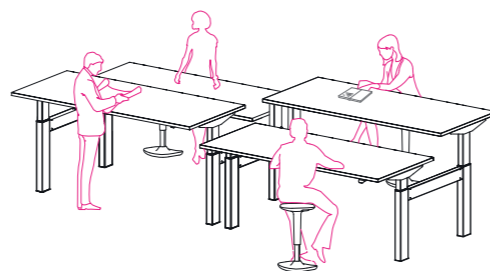
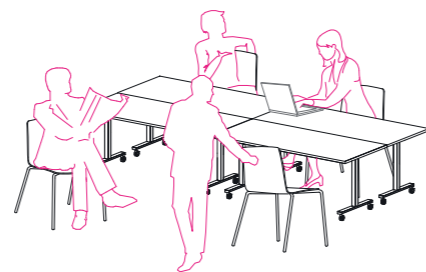
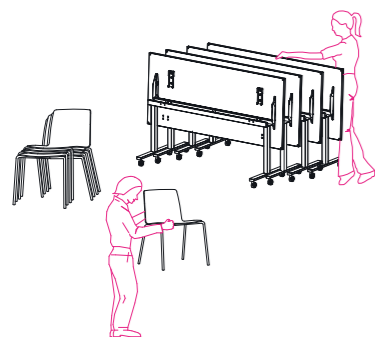

dynamic work

POSTAZIONI DI LAVORO COMODE, PERSONALIZZATE ED ERGONOMICHE, ADATTE AD AMBIENTI DI LAVORO DINAMICI E INFORMALI. LE SCRIVANIE REGOLABILI IN ALTEZZA (O SIT STAND DESK) CONSENTONO DI PASSARE FACILMENTE DALLA POSIZIONE SEDUTA A QUELLA IN PIEDI.

COMFORTABLE, CUSTOMISED AND ERGONOMIC WORKSTATIONS SUITABLE FOR DYNAMIC AND INFORMAL WORKING ENVIRONMENTS. HEIGHT ADJUSTABLE DESKS (OR SIT STAND DESKS) ALLOW TO SHIFT EASILY FROM SEATED TO STANDING POSITIONS.

POSTES DE TRAVAIL CONFORTABLES, INDIVIDUELS ET ERGONOMIQUES, ADAPTÉS AUX ENVIRONNEMENTS DE TRAVAIL DYNAMIQUES ET INFORMELS. LES BUREAUX RÉGLABLES EN HAUTEUR (OU BUREAUX ASSIS-DEBOUT) PERMETTENT DE PASSER FACILEMENT DE LA POSITION ASSISE À LA POSITION DEBOUT.

POP AD

Scrivanie e bench elevabili in altezza 1 step (da 73 a 113 cm). Struttura in metallo verniciato bianco (RAL 9010) e piano in melaminico rovere. Schermi divisorii rivestiti in tessuto King Flex - XFGC

1 step height-adjustable desks and bench desk (from 73 to 113 cm). White (RAL 9010) metal structure and oak melamine top. Screens upholstered in King Flex - XFGC fabric.

Bureaux et bureaux doubles réglables en hauteur 1 step (de 73 à 113 cm). Structure métallique blanche (RAL 9010) et plateau en mélamine chêne. Panneau écran revêtu en tissu King Flex - XFGC

CLASSE 6 - EM60

Seduta operativa / Task chair / Siège bureau
King Flex - XFYD



POP AD

Scrivanie e banchi elevabili in altezza 1 step (da 73 a 113 cm). Struttura in metallo verniciato bianco (RAL 9010) e piano in melaminico rovere.

1 step height-adjustable desks and bench desk from (73 to 113 cm). White (RAL 9010) metal structure and oak melamine top.

Bureaux et bureaux doubles réglables en hauteur 1 step (de 73 à 113 cm). Structure métallique blanche (RAL 9010) et plateau en mélamine chêne.

CLASSE 6 - EM60

Seduta operativa e sgabello
Task chair and stool
Siège bureau et tabouret
King Flex - XFYD



Pop Ad è la soluzione ottimale di scrivania regolabile in altezza perché è facilmente personalizzabile. Pop Ad rende l'ambiente lavorativo un luogo intelligente e dinamico. Il sistema integrato sit-stand permette di passare dal lavorare seduti a in piedi promuovendo il benessere delle persone e le esigenze di flessibilità dei moderni ambienti di lavoro.

Pop Ad is the optimal height-adjustable desk solution because it can be easily customised. Pop Ad makes the working environment an intelligent and dynamic place. The integrated sit-stand system makes it possible to switch from a sitting position to a standing one while working, promoting people's well-being and the flexibility requirements of modern working environments.

Pop Ad est la solution optimale de bureau réglable en hauteur car il peut être facilement personnalisé. Pop Ad fait de l'environnement de travail un lieu intelligent et dynamique. Le système intégré assis-debout permet de passer du travail en position assise au travail debout, ce qui favorise le bien-être des personnes et les exigences de flexibilité des environnements de travail contemporains.



POP AD

Bench elevabili in altezza 2 steps (da 65 a 125 cm). Struttura in metallo verniciato bianco (RAL 9010) e piano in melaminico rovere.

2 steps height-adjustable bench desk (from 65 to 125 cm). White (RAL 9010) metal structure and oak melamine top.

Bueaux doubles réglables en hauteur 2 steps (de 65 à 125 cm). Structure métallique blanche (RAL 9010) et plateau en mélamine chêne.

CLASSE 6 - EM60

Seduta operativa e sgabello
Task chair and stool
Siège bureau et tabouret
Rivet - T7G1

POP AD

Bench elevabili in altezza 2 steps (da 65 a 125 cm). Struttura in metallo verniciato bianco (RAL 9010) e piano in melaminico rovere.

2 steps height-adjustable bench desk (65 to 125 cm). White (RAL 9010) metal structure and oak melamine top.

Bureaux doubles réglables en hauteur 2 steps (65 à 125 cm). Structure métallique blanche (RAL 9010) et plateau en mélamine chêne.

CLASSE 6 - EM60

Seduta operativa / Task chair / Siège bureau
Bondai - TBM1



DETTAGLI TECNICI

Technical data/Données techniques



**Escursione in altezza 1 step
(73 ÷ 113 cm)**

1 STEP HEIGHT ADJUSTMENT (73 ÷ 113 cm)

**Escursione in altezza 2 steps
(65 ÷ 125 cm)**

2 STEPS HEIGHT ADJUSTMENT (65 ÷ 125 cm)

Pulsantiera Up and Down

UP AND DOWN PUSH-BUTTON

**Pulsantiera con display a spie
luminose**

4 funzioni "memory"

PUSH-BUTTON WITH INDICATOR LIGHTS DISPLAY
4 "MEMORY" FUNCTIONS

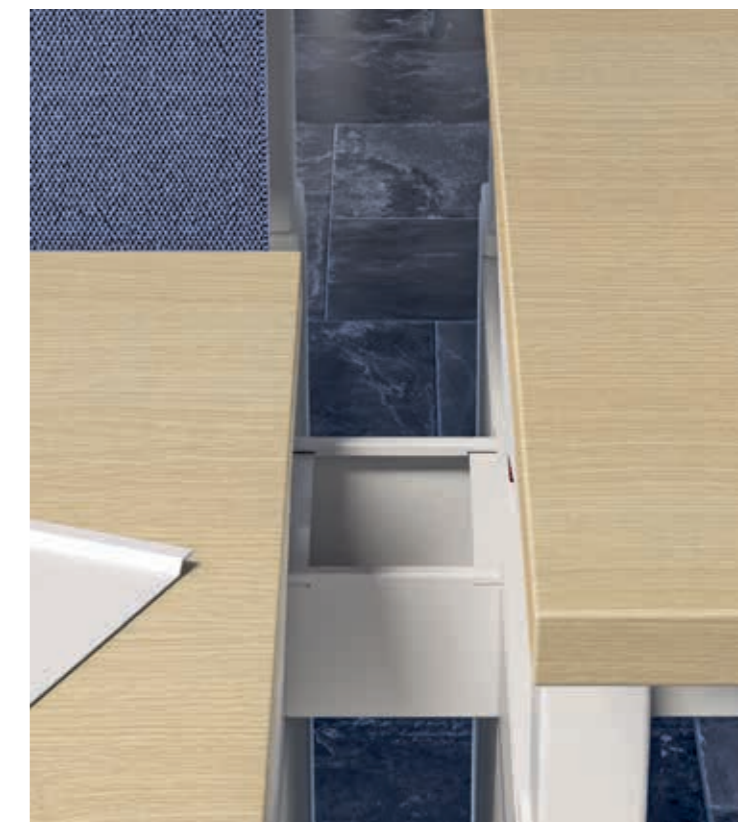



POP FOLDING

Tavolo ribaltabile su ruote.
Struttura in metallo verniciato
bianco (RAL 9010) e piano in
melaminico rovere.

Folding table on castors. White
(RAL 9010) metal structure and
oak melamine top.

Table pliante sur roulettes.
Structure métallique (RAL 9010)
blanche et plateau en mélamine
chêne.

YO

design Giacobone + Roj
Progetto CMR
Scocca / Unibody / Monocoque:
rovere naturale - natural oak
wood - chêne naturel
Telaio a slitta / Cantilever frame /
Piètement luge: blu pastello -
pastel blue - bleu pastel
(RAL 5024)

POP FOLDING

Tavolo ribaltabile su ruote. Struttura in metallo verniciato alluminio seta (RAL 9006) e piano in melaminico bianco.

Folding table on castors. Aluminium silk (RAL 9006) metal structure and white melamine top.

Table pliante sur roulettes. Structure métallique peinte en aluminium soie (RAL 9006) et plateau en mélamine blanche.

YO

design Giacobone + Roj Progetto CMR

Seduta multifunzione / Multipurpose chair /

Chaise polyvalente

Tessuto / Fabric / Tissu: Steelcut Trio 3 - SYRP

Telaio a slitta / Cantilever frame /

Piètement luge: Bianco / White / Blanc RAL 9010



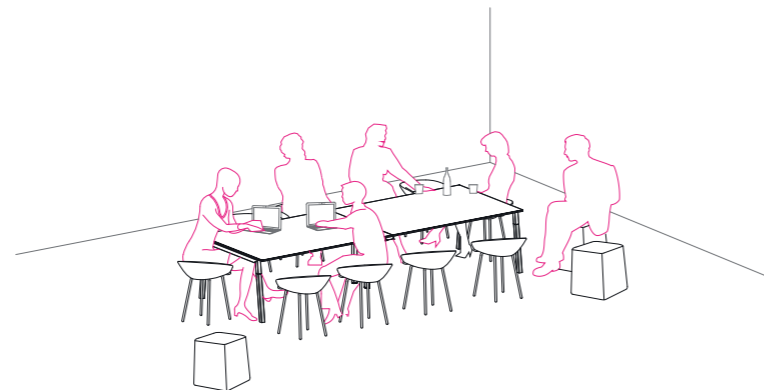
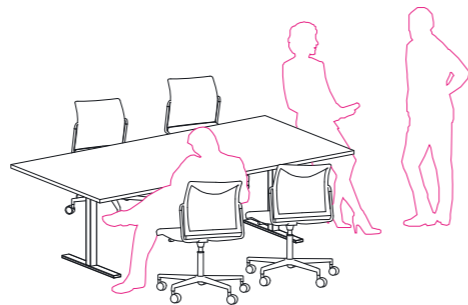
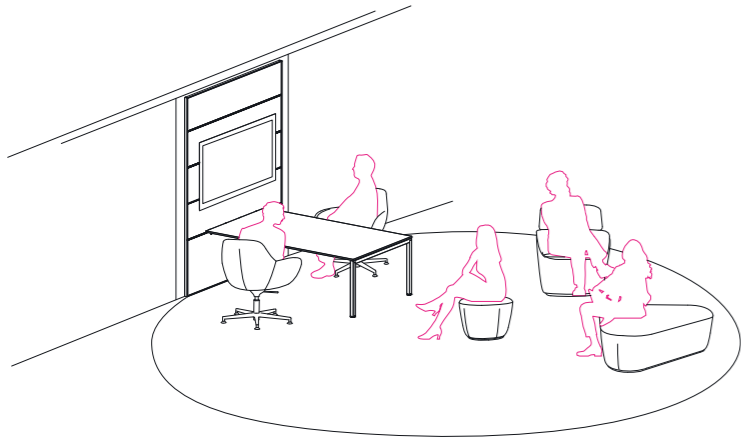
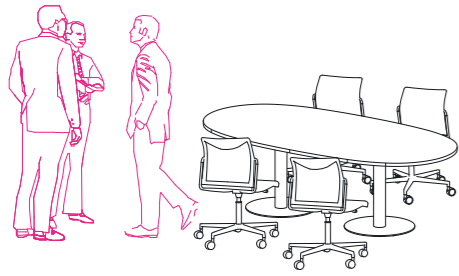

meeting

I TAVOLI RIUNIONE POP SONO LA SCELTA FLESSIBILE E FUNZIONALE: UNA GAMMA COMPLETA CHE SODDISFA TUTTE LE ESIGENZE DELL'UFFICIO. I TAVOLI MEETING POP SONO PROPOSTI IN DUE ALTEZZE, 74 E 105 CM.

POP MEETING TABLES ARE THE FLEXIBLE AND FUNCTIONAL CHOICE FOR DYNAMIC MEETINGS. THE COMPLETE RANGE MEETS ALL THE OFFICE NEEDS. POP MEETING TABLES ARE PROPOSED IN TWO DIFFERENT HEIGHTS, 74 AND 105 CM.

LES TABLES RÉUNION POP SONT LE CHOIX FLEXIBLE ET FONCTIONNEL: UNE GAMME COMPLÈTE QUI RÉPOND À TOUS LES BESOINS DU BUREAU. LES TABLES RÉUNION POP SONT PROPOSÉES EN DEUX HAUTEURS, 74 ET 105 CM.

POP ACE

Tavolo riunione L. 320 cm P. 125 cm H. 74 cm con struttura metallica finitura alluminio seta (RAL 9006) e piano melaminico bianco.

Meeting table W. 320 cm D. 125 cm H. 74 cm with aluminium silk (RAL 9006) metal structure and white melamine top.

Table réunion L. 320 cm P. 125 cm Ht. 74 cm avec structure métallique aluminium soie (RAL 9006) et plateau en mélamine blanche.

YO

design Giacobone + Roj Progetto CMR
Seduta multifunzione / Multipurpose chair /
Chaise polyvalente
Tessuto / Fabric / Tissu: Remix 3 - RIRG
Telaio 4 gambe / 4-leg frame / Bâti 4 pieds:
Rosso / Red / Rouge RAL 3020

POP ACE

Tavolo riunione L. 140 cm P. 80 cm H. 105 cm con struttura metallica finitura alluminio seta (RAL 9006) e piano melaminico bianco.

Meeting table W. 140 cm D. 80 cm H. 105 cm with aluminium silk (RAL 9006) metal structure and white melamine top.

Table réunion L. 140 cm P. 80 cm Ht. 105 cm avec structure métallique finition aluminium soie (RAL 9006) et plateau en mélamine blanche.

YO STOOL

design Giacobone + Roj Progetto CMR
Sgabello / Stool / Tabouret
Tessuto / Fabric / Tissu: Remix 3 - RIRG
Telaio a slitta / Cantilever frame / Piètement
luge: Rosso / Red / Rouge RAL 3020



POP WOODY

Tavolo riunione modulare (P. 125 cm) con struttura in metallo verniciato nero (RAL 9005) e gamba in frassino naturale verniciato trasparente. Piano in melaminico bianco.

Modular meeting table (D. 125 cm) with black metal structure (RAL 9005) and leg in natural ash, clear varnished. White melamine top.

Table de réunion modulaire (P. 125 cm) avec structure métallique noire (RAL 9005) et piétement en frêne naturel verni transparent. Plateau en mélamine blanche.

YO

design Giacobone + Roj Progetto CMR
Seduta multifunzione / Multipurpose chair /
Chaise polyvalente
Tessuto / Fabric / Tissu: Era - T8G1, T8R2, R8B0
Telaio 4 gambe / 4-leg frame / Bâti 4 pieds:
Nero / Black / Noir RAL 9005



Tavoli riunione modulari, proposti sia in forma quadrata che rettangolare, si prestano per sale meeting informali. Con diverse soluzioni di cablaggio.

Modular meeting tables, both square and rectangular in shape, are suitable for informal meeting rooms. They come with different wiring solutions.

Les tables de réunion modulaires, disponibles en formes carrées et rectangulaires, conviennent aux salles de réunion informelles. Avec différentes solutions de câblage.

YO

design Giacobone + Roj Progetto CMR
Seduta multifunzione / Multipurpose chair /
Chaise polyvalente
Tessuto / Fabric / Tissu: Era - T8R3
Telaio 4 gambe / 4-leg frame / Bâti 4 pieds:
Bianco / White / Blanc RAL 9010



KARL
design L. Nichetto
Sgabello H. 51 cm
Stool H. 51 cm
Tabouret Ht. 51 cm
Tessuto / Fabric / Tissu: Remix 3 - RIRB, RIRG, RIRE

POP EASY

Tavolo riunione modulare con struttura in metallo verniciato nero (RAL 9005) e piano in melaminico tortora.

Modular meeting table with black metal structure (RAL 9005) and dove melamine top.

Table réunion modulaire avec structure métallique noire (RAL 9005) et plateau en mélamine gris taupe.

YO

design Giacobone + Roj Progetto CMR
Seduta multifunzione / Multipurpose chair /
Chaise polyvalente
Tessuto / Fabric / Tissu: Remix 3 - RIGC
Telaio a slitta / Cantilever frame / Piètement
luge: nero / black / noir RAL 9005





POP EASY

Tavolo riunione modulare con struttura in metallo verniciato nero (RAL 9005) e piano in melaminico noce canaletto.

Modular meeting table with black (RAL 9005) metal structure and american walnut melamine top.

Table de réunion modulaire avec structure métallique noire (RAL 9005) et plateau en mélamine noyer américain.

FIOR DI LOTO

design C. Bellini
Seduta multifunzione
Multipurpose chair
Siège polyvalent

Tessuto / Fabric / Tissu:
Era - T8R1



POP PANEL

Tavolo riunione con piano e struttura in melaminico noce canaletto.

Meeting table with american walnut melamine top and structure.

Table de réunion avec plateau et structure en mélamine noyer américain.



POP TEE

Tavolo riunione con struttura a due colonne in metallo bianco (RAL 9010) e piano ovale in melaminico bianco.

Meeting table with 2-column white (RAL 9010) metal structure and white melamine oval top.

Table de réunion avec structure à deux colonnes en métal blanc (RAL 9010) et plateau ovale en mélamine blanche.

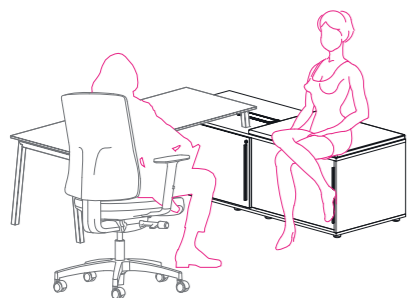
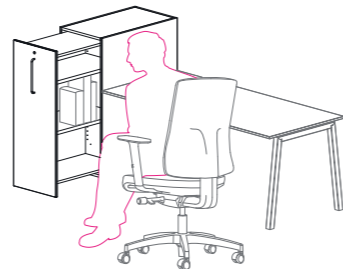
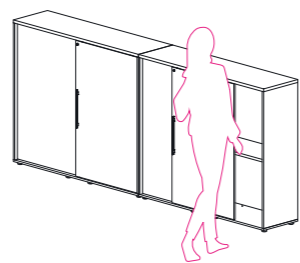
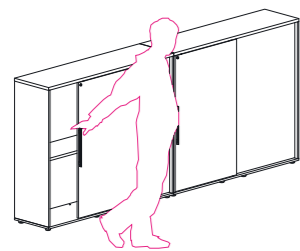
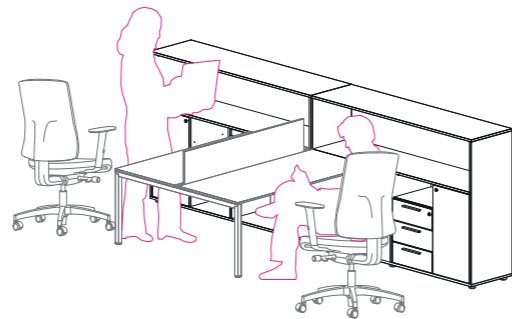
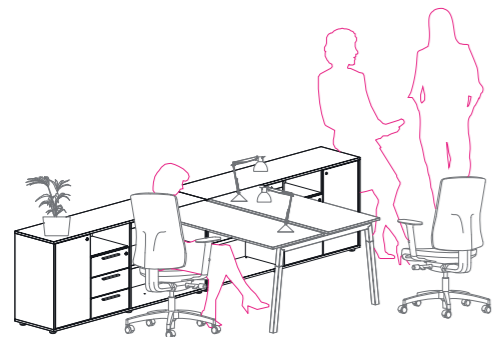
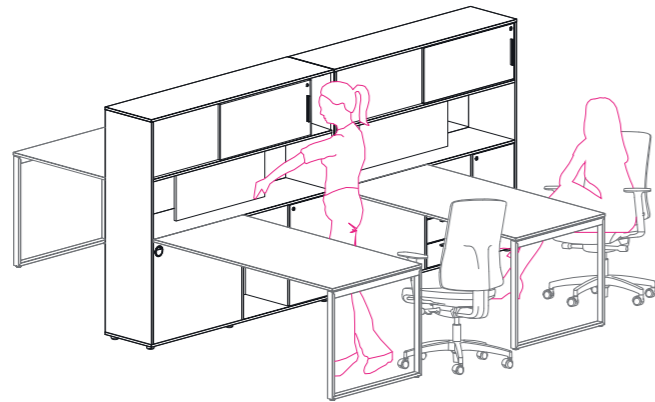

organized workspace

ORGANIZZARE IL PROPRIO SPAZIO DI LAVORO. CONTENITORI, CASSETTI E LIBRERIE RAPPRESENTANO LA SOLUZIONE PIÙ EFFICIENTE PER OTTIMIZZARE ED ORGANIZZARE AL MEGLIO LA POSTAZIONE DI LAVORO. DIVERSE PROPOSTE DI ARCHIVIAZIONE CHE RISPONDONO A OGNI ESIGENZA, AGGIUNGO VALORE ESTETICO ED AUMENTANO IL PROPRIO SPAZIO DI LAVORO.

ORGANISING ONE'S OWN WORK SPACE IS AN IMPORTANT TASK. STORAGE UNITS, DRAWERS AND SHELVING ARE THE MOST EFFICIENT WAY TO OPTIMISE AND ORGANISE A WORKSPACE. DIFFERENT STORAGE PROPOSALS MEET DIFFERENT NEEDS, ADD SPECIFIC AESTHETIC VALUES AND ENHANCE YOUR WORKSPACE.

ORGANISER VOTRE ESPACE DE TRAVAIL. LES MEUBLES DE RANGEMENT, LES CAISSONS ET LES LIBRAIRIES SONT LE MOYEN LE PLUS EFFICACE D'OPTIMISER ET D'ORGANISER VOTRE ESPACE DE TRAVAIL. IL EXISTE DIFFÉRENTES OPTIONS DE RANGEMENT QUI RÉPOND À TOUS LES BESOINS, D'AJOUTER UNE VALEUR ESTHÉTIQUE ET D'AUGMENTER L'ESPACE UTILE DE TRAVAIL.



CABINETS H. 74 cm

Armadio H. scrivania L 165 cm, con 1 anta battente, cassettiera 3 cassetti e vani a giorno.

Desk-height cabinet W. 165 cm, with single hinged door, 3 drawers pedestal and open compartments.

Armoire Ht. bureau L 165 cm, avec 1 porte battante, caisson avec 3 tiroirs et des niches ouverts.

CLASSE 4 - EM46

Seduta operativa / Task chair / Siège bureau

Rete / Mesh / Résille: Polo - RPZO

Tessuto / Fabric / Tissu: Bondai - TBGC



CABINETS H. 114

Armadi L. 165 cm con anta battente, vani a giorno inferiori con schiena in melaminico. Vano a giorno superiore con schiena rivestita in tessuto.

165 cm wide cabinets with hinged door, open lower unit with melamine back. Open upper unit with fabric covered back.

Armoires L. 165 cm avec porte battante, compartiments inférieurs ouverts, avec fond en mélamine. Compartiment supérieur ouvert avec fond revêtu en tissu.

CLASSE 4 - EM49

Seduta operativa / Task chair / Siège bureau

Rete / Mesh / Résille: Polo - RPZO

Tessuto / Fabric / Tissu:

Bondai - TBBE



La collezione di armadi per ufficio offre diverse soluzioni e configurazioni per la gestione dell'archiviazione in ufficio. Armadi ad altezza scrivania proposti con ante battenti o scorrevoli, cassettiere, moduli a giorno e ripiani da utilizzare come libreria. Disponibili in tre altezze.

The office cabinet collection offers various solutions and configurations for office space management. Desk-height cabinets with hinged or sliding doors, pedestals, open units and shelves used as bookcases are available in three heights.

La collection d'armoires offre différentes solutions et configurations pour organiser le rangement au bureau. Des armoires à hauteur de bureau avec des portes battantes ou coulissantes, des caissons, des unités ouvertes et des étagères à utiliser comme bibliothèques. Trois hauteurs disponibles.

CABINETS H. 154 cm

Armadi L. 165 cm con 1 anta battente e cassetiera 3 cassetti, vano a giorno superiore con schiena rivestita in tessuto. Vano terzo livello con ante scorrevoli e serratura integrata.

Cabinets W. 165 cm with 1 hinged door and 3 drawer pedestal, upper open compartment with fabric upholstered back. Third level compartment with sliding doors and integrated lock.

Armoires L. 165 cm avec 1 porte battante et caisson avec 3 tiroirs, compartiment supérieur ouvert avec fond revêtu en tissu. Compartiment troisième niveau avec portes coulissantes et serrure intégrée.

FIOR DI LOTO

design C. Bellini
Seduta multifunzione con carter retro schienale in plastica Baydur.
Step - TBB6

Multipurpose chair with rear side of backrest in Baydur plastic.

Siège polyvalent avec arrière du dossier en plastique Baydur.



WORKWALL

Boiserie H. 195 cm con pensili L. 140 cm e apertura verso l'alto.
Pannelli in melaminico rovere e rivestiti in tessuto.

Boiserie H. 195 cm with 140 cm wide storage modules opening upwards. Oak melamine and upholstered fabric panels.

Boiserie Ht. 195 cm avec conteneurs suspendus L. 140 cm et ouverture vers le haut. Panneaux en mélamine chêne et revêtus en tissu.

CLASSE 4 - EM49

Seduta operativa / Task chair / Siège bureau
Rete / Mesh / Résille: Polo - RPZ0
Tessuto / Fabric / Tissu: Bondai - TBB2





WORKWALL

Boiserie H. 195 cm con modulo contenitore (L. 140 cm) con apertura verso l'alto. Pannelli in melaminico rovere e rivestiti in tessuto.

Boiserie H. 195 cm with 140 cm wide storage modules opening upwards. Oak melamine and upholstered fabric panels.

Boiserie Ht. 195 cm avec conteneur L. 140 cm avec ouverture vers le haut. Panneaux en mélamine chêne et revêtus en tissu.

CLASSE 4 - EM49

Seduta operativa / Task chair / Siège bureau
 Rete / Mesh / Résille: Polo - RPZO
 Tessuto / Fabric / Tissu: Bondai - TBB2

WORKWALL

Boiserie H. 195 cm con moduli contenitori L. 160 cm con apertura verso l'alto. Pannelli in melaminico cemento e rivestiti in tessuto.

Boiserie H. 195 cm with 160 cm wide storage modules opening upwards. Concrete texture melamine and upholstered fabric panels.

Boiserie Ht. 195 cm avec conteneurs suspendus L. 160 cm et ouverture vers le haut. Panneaux en mélamine béton et revêtus en tissu.

CLASSE 4 - EM49

Seduta operativa / Task chair / Siège bureau
 Rete / Mesh / Résille: Polo - RPG1
 Tessuto / Fabric / Tissu: Boss FR - T4V1

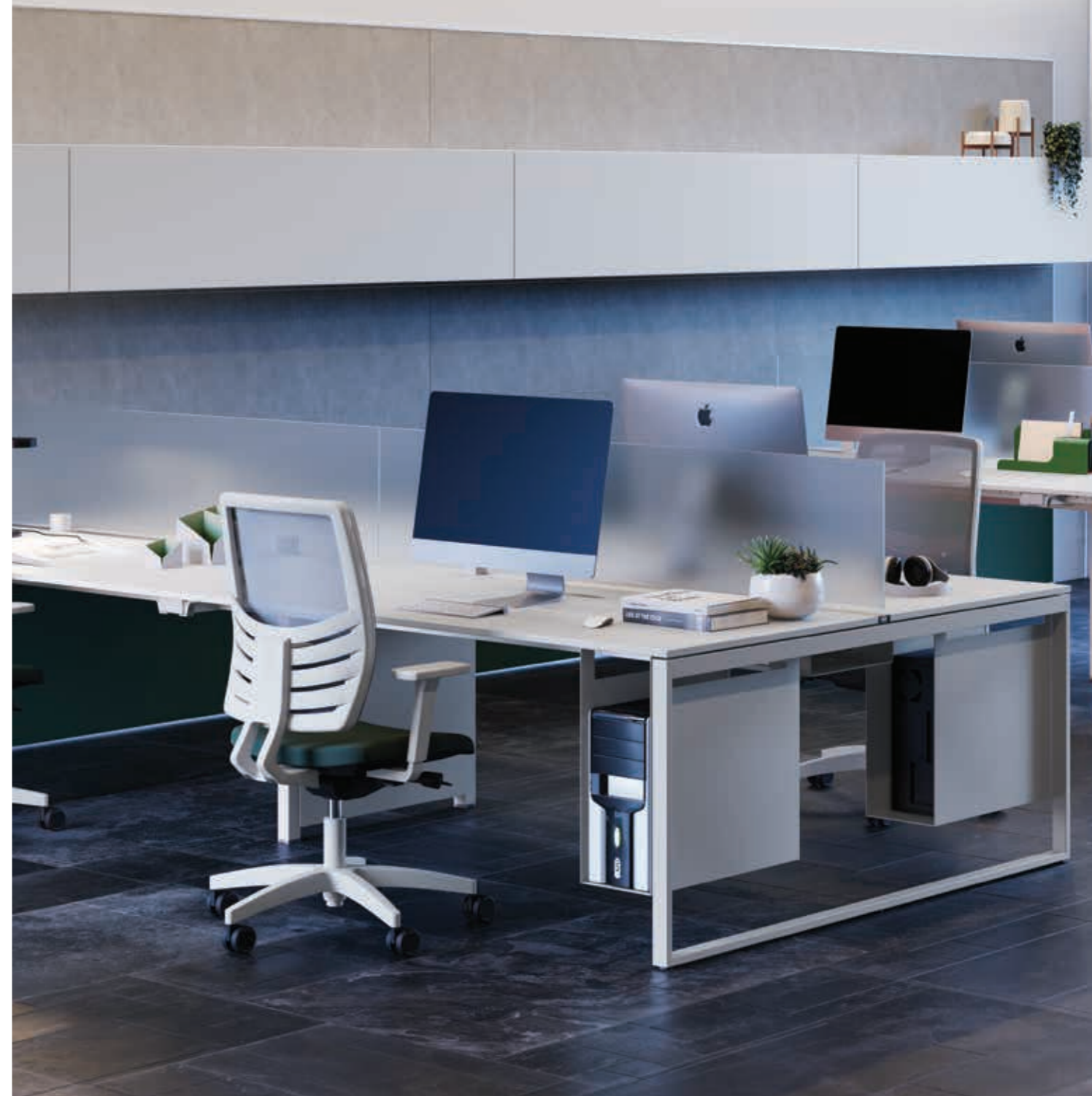



Alla boiserie si possono agganciare scrivanie, mensole e contenitori pensili a giorno, con anta battente, a ribalta e con apertura verso l'alto.

CLASSE 4 - EM49
 Seduta operativa / Task chair / Siège bureau
 Rete / Mesh / Résille: Polo - RPG1
 Tessuto / Fabric / Tissu: Boss FR - T4V1

The boiserie can be equipped with desks, shelves, open hanging units, hanging units that open upwards or hanging units with a hinged or flap door.

La boiserie peut être équipée avec bureaux, étagères, éléments suspendu ouvertes, éléments suspendus avec portes battantes, ou porte à rabat, ou avec ouverture parallèle vers le haut.

Isole operative collegate
a mobili di servizio adibiti ad archivio
e ad elementi di appoggio.

OPERATIVE SYSTEMS LINKED TO SERVICE FILING CABINETS.
ÎLOTS DE TRAVAIL CONNECTÉS À DES MEUBLES DE SERVICE UTILISÉS
COMME RANGEMENT.



CLASSE 4 - EM49
Seduta operativa / Task chair /
Siège bureau
Rete / Mesh / Rèsille: Polo - RPZO
Tessuto / Fabric / Tissu:
Bondai - TBV2



CABINETS H. 56 cm
Mobile di servizio portante L. 165 cm con ante scorrevoli.

Supporting service cabinets W. 165 cm with sliding doors.

Meuble de service portant L. 165 cm avec portes coulissantes.

FIOR DI LOTO
design C. Bellini
Seduta multifunzione con carter retro schienale in plastica Baydur.

Multipurpose chair with rear side of backrest in Baydur plastic.

Siège polyvalent avec arrière du dossier en plastique Baydur.

Step - STSB



mobili di servizio: la praticità di utilizzare il mobile di servizio sia come seduta che elemento di archiviazione. Ogni mobile ha un vano interno predisposto per la salita cavi.

service cabinets: because of their double function (both as a seat and as a filing element), service cabinets have a great potential. Each cabinet has an inner compartment where cables can be put.

meuble de service: la praticité d'utiliser le meuble de service comme un siège et un élément de rangement. Chaque meuble a un compartiment interne conçu pour l'entrée.

Nel sistema scrivanie pop si integrano diverse tipologie di contenitori quali cassettiere, orgatower e armadi studiati come elementi salvaspazio.

DIFFERENT PIECES OF FURNITURE CAN COMPLETE THE OFFER OF THE POP DESKS: PEDESTALS, ORGATOWER AND CABINETS DESIGNED AS SPACE-SAVING ELEMENTS.

DANS LE SYSTÈME POP SONT INTÉGRÉS DIFFÉRENTS TYPES DE CONTENEURS TELS QUE DES TIROIRS, DES ORGATOWER ET DES ARMOIRES CONÇUES COMME DES ÉLÉMENTS PEU ENCOMBRANTS.



ORGATOWER

Contenitore H. 114 cm con anta estraibile frontalmente.

Cabinet H. 114 cm with front pull-out door.

Cabinet Ht. 114 cm avec porte extractible à l'avant.

FIOR DI LOTO

design C. Bellini
Seduta multifunzione con carter retro schienale in plastica Baydur.
Jet - JTGM

Multipurpose chair with rear side of backrest in Baydur plastic.

Siège polyvalent avec arrière du dossier en plastique Baydur.





orgatower: crea uno spazio adatto a riporre ed archiviare in aree ridotte. Proposto con diversi accessori.

orgatower: this element creates space for storage and filing in small areas. Available with different accessories.

orgatower: crée un espace adapté au rangement et à l'archivage dans les petites zones. Disponible avec différents accessoires.



orgatower: configurabile con diversi accessori come telai estraibili per il supporto di cartelle sospese, cassetto estraibile oppure ripiani per l'archiviazione.

orgatower: configurable with different accessories such as pull-out frames to support hanging folders, pull-out drawers or shelves for storage.



orgatower: configurable avec différents accessoires tels que des châssis télescopiques pour supporter des dossiers suspendus, des tiroirs télescopiques ou des étagères pour l'archivage.

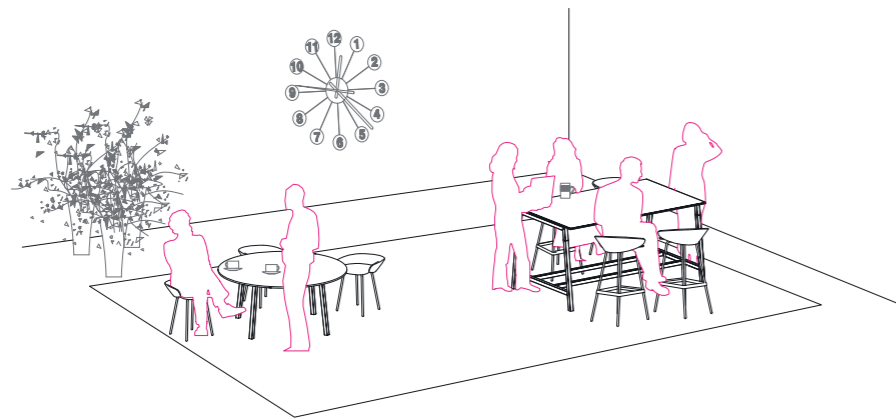
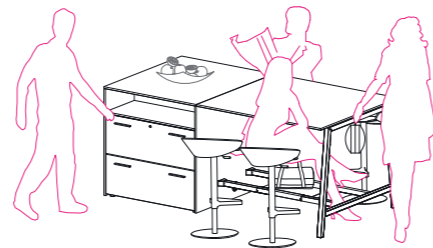
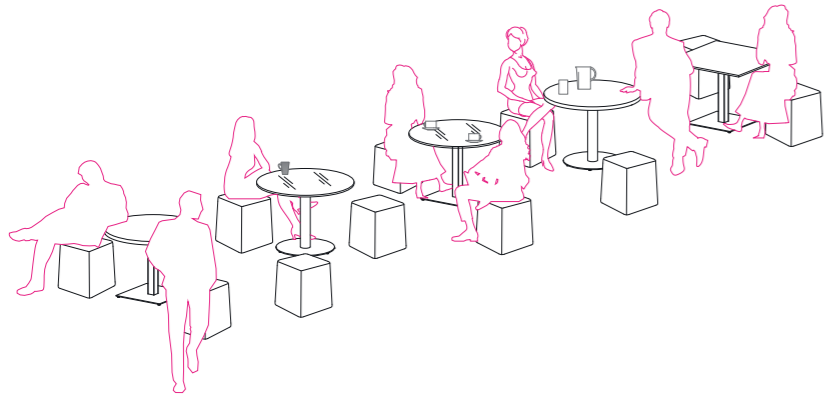
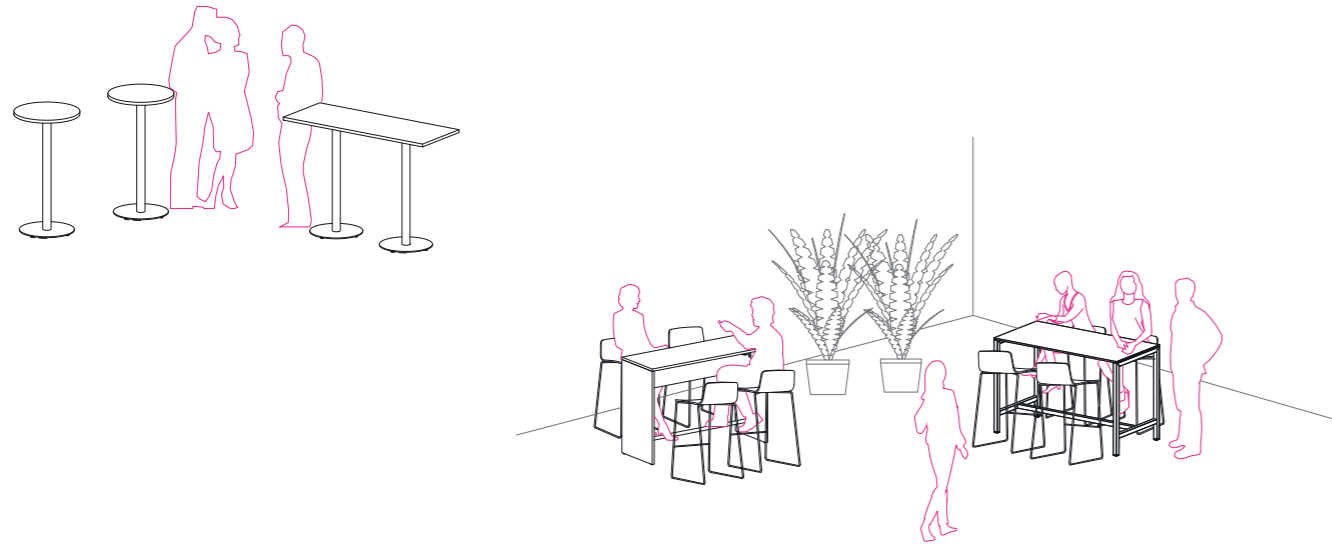

break out

LA COLLABORAZIONE E LA CONDIVISIONE DI IDEE SONO ALLA BASE DELLA PRODUTTIVITÀ. L'AREA BREAK OUT È IL LUOGO IN CUI I DIPENDENTI SI INCONTRANO, LAVORANO E SOCIALIZZANO. È UN'AREA STRATEGICA CHE TRASFORMA IL LUOGO DI LAVORO PER IL BENESSERE DELL'INDIVIDUO.

COLLABORATING AND SHARING IDEAS ARE THE BASIS OF PRODUCTIVITY. THE BREAK OUT AREA IS THE PLACE WHERE EMPLOYEES MEET, WORK AND SOCIALISE. IT'S A STRATEGIC AREA THAT TRANSFORMS THE WORKPLACE FOR THE WELL-BEING OF THE PEOPLE.

LA COLLABORATION ET LE PARTAGE DES IDÉES SONT LA BASE DE LA PRODUCTIVITÉ. L'ESPACE DE DÉTENTE EST LE LIEU DE RENCONTRE, DE TRAVAIL ET DE SOCIALISATION DES EMPLOYÉS. ELLE EST UNE ZONE STRATÉGIQUE QUI TRANSFORME LE LIEU DE TRAVAIL POUR LE BIEN-ÊTRE DE L'INDIVIDU.

POP ACE

Tavoli alti H. 105 cm, P. 80/125 cm con struttura in metallo verniciato bianco (RAL 9010) e piano in melaminico bianco.

High tables H. 105 cm, D. 80/125 cm with white metal structure (RAL 9010) and white melamine top.

Tables hautes Ht. 105 cm, P. 80/125 cm avec structure métallique blanche (RAL 9010) et plateau en mélamine blanche.

KARL

design L. Nichetto

Sgabello / Stool / Tabouret

Tessuto / Fabric / Tissu: Steelcut Trio 3 - SIRE





Postazioni agili e flessibili che si declinano in tavoli alti e in tavoli multifunzione completi di contenitori per lavorare in team e fare piccole pause relax. Un approccio ideale per aree di condivisione e informali.

POP ACE

Tavolo alto H. 105 cm, P. 125 cm con struttura in metallo verniciato nero (RAL 9005) e piano in melaminico noce canaletto.

YO STOOL

design Giacobone + Roj Progetto CMR
Sgabello / Stool / Tabouret
Tessuto / Fabric / Tissu: Remix 3 - RIGC, RIRB, RIRG

Agile and flexible workstations in the form of high tables and multifunctional tables with containers allow to work as a team and have a small relaxing breaks. An ideal solution for sharing and informal areas.

High table H. 105 cm, D. 125 cm with black (RAL 9005) metal structure and american walnut melamine top.

Poste de travail agiles et flexibles sous forme de tables hautes et de tables multifonctionnelles complète avec des armoires qui permettent de travailler en équipe et bénéficier de petites pauses relaxantes. Une approche idéale pour les espaces informels et à partager.

Table haute Ht. 105 cm, P. 125 cm avec structure métallique noire (RAL 9005) et plateau en mélamine noyer américain.



POP WOODY

Tavolo alto H. 105 cm, P. 125 cm con struttura in metallo verniciato bianco (RAL 9010) e gambe in frassino naturale verniciato trasparente. Piano e contenitori in melaminico bianco.

High table H. 105 cm, D. 125 cm with white metal structure (RAL 9010) and leg in natural ash, clear varnished. White melamine top and cabinets.

Table haute Ht. 105 cm, P. 125 cm avec structure métallique blanche (RAL 9010) et piétement en frêne naturel verni transparent. Plateau et cabinets en mélamine blanche.

KARL

design L. Nichetto
Sgabello / Stool / Tabouret
Tessuto / Fabric / Tissu: Remix 3 - RIRB, RIYE



POP TABLES
Tavoli alti H. 105 cm, P. 60 cm con
struttura e piano in melaminico
bianco.

High tables H. 105 cm, D. 60 cm
with white melamine structure
and top.

Tables hautes Ht. 105 cm, P. 60
cm avec structure et plateau en
mélamine blanche.

KARL
design L. Nichetto
Sgabello / Stool / Tabouret
Tessuto / Fabric / Tissu:
Skill - PGCG



POP TABLES

Tavolo alto H. 105 cm, P. 60 cm con struttura in metallo verniciato bianco (RAL 9010) e piano in melaminico bianco.

High table H. 105 cm, D. 60 cm with white (RAL 9010) metal structure and white melamine top.

Table haute Ht. 105 cm, P. 60 cm avec structure métallique blanche et plateau en mélamine blanche.

KARL

design L. Nichetto
Sgabello / Stool / Tabouret
Tessuto / Fabric / Tissu:
Steelcut Trio 3 - SYMA

POP TABLES

Tavolo alto H. 105 cm, Ø 60 cm con struttura in metallo verniciato bianco (RAL 9010) e piano circolare in melaminico bianco.

Tavolo alto H. 105 cm, P. 60 cm con struttura e piano in melaminico bianco.

KARL

design L. Nichetto
Sgabello / Stool / Tabouret
Tessuto / Fabric / Tissu: Jet - JTR1, JTC1

High table H. 105 cm, Ø 60 cm with white metal structure (RAL 9010) and white melamine round top.

High table H. 105 cm, D. 60 cm with white melamine structure and top.

Table haute Ht. 105 cm, Ø 60 cm avec structure métallique blanche (RAL 9010) et plateau circulaire en mélamine blanche.

Table haute Ht. 105 cm, P. 60 cm avec structure et plateau en mélamine blanche.



POP TABLES

Tavoli regolabili in altezza (88<125 cm) su ruote con struttura metallica finitura cromo lucido e piano circolare (Ø 60 cm) in melaminico bianco.

Height-adjustable tables (88<125 cm) on castors with polished chrome metal structure and white melamine round top (Ø 60 cm).

Tables réglables en hauteur (88<125 cm) sur roulettes avec structure en métal chrome poli et plateau rond (Ø 60 cm) en mélamine blanche.

KARL

design L. Nichetto
Sgabello / Stool / Tabouret
Tessuto / Fabric / Tissu: Era - T8V8

RADAR

design Claesson, Koivisto, Rune
Poltrona / Armchair / Fauteuil
Tessuto / Fabric / Tissu: Era - T8BA

**POP TABLES**

Tavoli regolabili in altezza (75<113 cm) con struttura metallica finitura cromo lucido e piano circolare (Ø 60 cm) in melaminico bianco.

Height-adjustable tables (75<113 cm) with polished chrome metal structure and white melamine round top (Ø 60 cm).

Tables réglables en hauteur (75<113 cm) avec structure en métal chromé poli et plateau rond (Ø 60 cm) en mélamine blanche.

YO

design Giacobone + Roj
Progetto CMR

Seduta multifunzione con monoscocca in rovere naturale.

Multipurpose chair with natural oak unibody.

Chaise polyvalente avec mono-coque en chêne naturel.



POP ACE
Tavoli circolari con struttura in metallo bianco (RAL 9010) e piano in melaminico rovere con netbox point integrato.
YO
design Giacobone + Roj Progetto CMR
Seduta multifunzione / Multipurpose chair
Chaise polyvalente

Round tables with white (RAL 9010) metal structure and oak melamine top with netbox point included.

Tessuto / Tissu / Fabric:
Remix 3 - RIB1

Tables rondes avec structure en métal blanc (RAL 9010) et plateau en mélamine chêne avec netbox point intégré.

Telaio a 4 gambe / 4-leg frame / Bâti 4 pieds:
Blu pastello / Pastel blu / Bleu pastel RAL 5024



POP TABLE
Tavolo circolare con struttura a colonna in metallo bianco (RAL 9010) e piano in melaminico rovere.

YO
design Giacobone + Roj Progetto CMR
Seduta multifunzione con monoscoeca in rovere sbiancato.

Round table with white (RAL 9010) metal column structure and oak melamine top.

Multipurpose chair with whitened oak unibody.

Table ronde avec structure à colonne en métal blanc (RAL 9010) et plateau en mélamine chêne.

Chaise polyvalente avec monocoque en chêne blanchi.



Tavoli multifunzione disponibili in varie forme, dimensioni e colorimetrie. In opzione, possibilità di elettrificare la colonna centrale.

Multifunctional tables available in various shapes, sizes and colours. The column can be equipped with cable management.

Tables multifonctionnelles disponibles en différentes formes, tailles et couleurs. Électrification facultative de la colonne centrale.

POP TABLES

Tavolo circolare con struttura a colonna in metallo nero (RAL 9005) e piano in vetro nero.
Tavolo circolare con struttura a colonna in metallo bianco (RAL 9010) e piano in melaminico tortora.
Tavolo quadrato con struttura a colonna in metallo nero (RAL 9005) e piano in melaminico noce canaletto.

Round table with black (RAL 9005) metal column structure and black glass top.
Round table with white (RAL 9010) metal column structure and dove melamine top.
Square table with black (RAL 9005) metal column structure and american walnut melamine top.

Table circulaire avec structure à colonne en métal noir (RAL 9005) et plateau en verre noir.
Table circulaire avec structure à colonne en métal blanc (RAL 9010) et plateau en mélamine gris taupe.
Table carré avec structure à colonnes en métal noir (RAL 9010) et plateau en mélamine noyer américain.



I tavoli Pop regolabili in altezza uniscono tutti i vantaggi del moderno concetto di high desking, sono infatti ideali per il lavoro agile in team o come punto di incontro per la comunicazione. Un'altezza regolabile che va da 75 cm a 113 cm per la versione con base fissa, e da 88 cm a 125 cm per la versione con ruote.

The height-adjustable Pop tables combine all the advantages of the modern high desking concept and are ideal for agile teamwork or as a meeting point for communication. The fixed version has an adjustable height that goes from 75 cm to 113 cm, while the version on castors can go from 88 cm to 125 cm.

Les tables Pop réglables en hauteur combinent tous les avantages du concept moderne de bureau en hauteur et sont idéales pour un travail d'équipe agile ou comme point de rencontre pour la communication. Avec une hauteur réglable de 75 cm à 113 cm pour la version base fixe, et de 88 cm à 125 cm pour la version à roulettes.

POP TABLES

Tavoli circolari elevabili in altezza con struttura a colonna in metallo bianco (RAL 9010) e piano in melaminico rovere.

Height-adjustable round tables with white (RAL 9010) metal column structure and oak melamine top.

Tables circulaires réglables en hauteur avec structure à colonne en métal blanc (RAL 9010) et plateau en mélamine chêne.

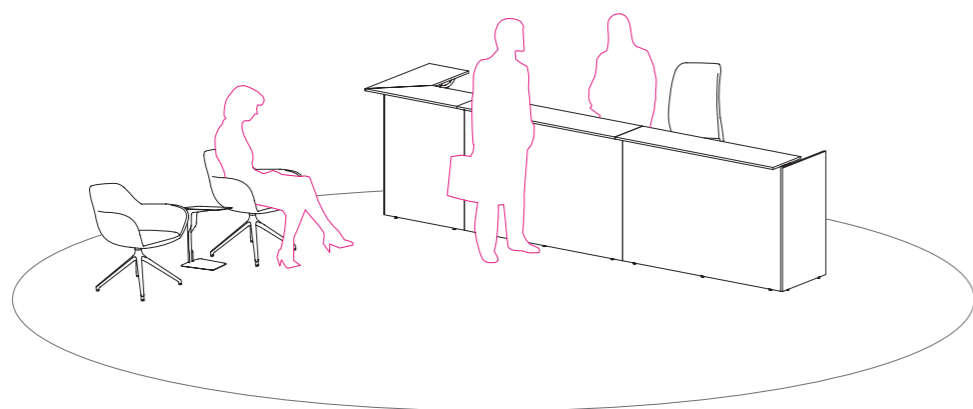
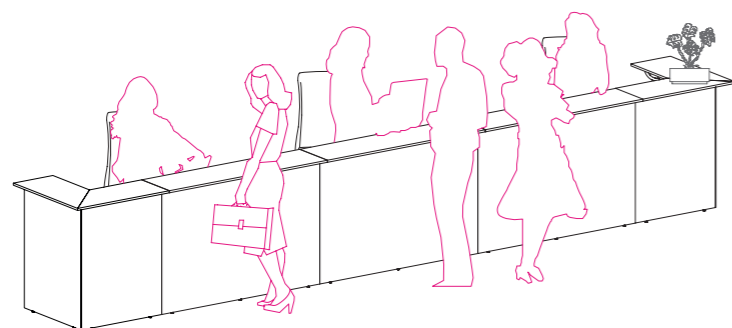

welcome

NELLA PROGETTAZIONE DI UN UFFICIO MODERNO,
ANCHE I DETTAGLI PARLANO DELL'AZIENDA, COMUNICANO IL
BRAND E I SUOI VALORI.

WHEN DESIGNING A MODERN OFFICE ALL ELEMENTS MUST
COMMUNICATE THE COMPANY'S BRAND AND VALUES.

DANS LA CONCEPTION D'UN BUREAU MODERNE, MÊME LES
DÉTAILS RACONTENT L'ENTREPRISE, COMMUNIQUENT LA MARQUE
ET SES VALEURS.

BAGUETTE
Reception modulare in melaminico bianco.
White melamine modular reception.
Banque d'accueil modulaire en mélamine blanche.





BAGUETTE

Reception modulare in
melaminico bianco.

White melamine modular
reception.

Banque d'accueil modulaire en
mélamine blanche.

BAGUETTE
Reception modulare in
melaminico bianco.
White melamine modular
reception.
Banque d'accueil modulaire en
mélamine blanche.



BAGUETTE
Reception modulare in
melaminico bianco.
White melamine modular
reception.
Banque d'accueil modulaire en
mélamine blanche.

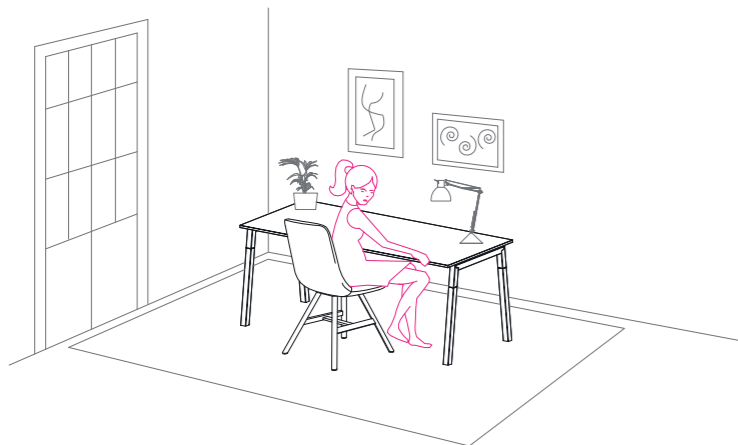

home

IN UN'EPOCA DI CRESCENTE LAVORO A DISTANZA, DIVENTA ANCORA PIÙ IMPORTANTE CREARE E INCORAGGIARE UNA FORTE CULTURA DI SQUADRA. L'ARREDAMENTO, LA TECNOLOGIA E IL DESIGN POSSONO GIOCARE UN RUOLO SOSTANZIALE NEL RENDERE IL LAVORO A DISTANZA PIÙ FLUIDO.

AS REMOTE WORKING INCREASES, CREATING AND FOSTERING A STRONG TEAM CULTURE BECOMES EVEN MORE IMPORTANT. FURNITURE, TECHNOLOGY AND ENVIRONMENT DESIGN CAN PLAY A SUBSTANTIAL ROLE IN MAKING REMOTE WORKING MORE FLUID.

À UNE ÉPOQUE OÙ LE TRAVAIL À DISTANCE SE DÉVELOPPE, IL DEVIENT ENCORE PLUS IMPORTANT DE CRÉER ET D'ENCOURAGER UNE CULTURE D'ÉQUIPE FORTE. LE MOBILIER, LA TECHNOLOGIE ET LA CONCEPTION DE L'ENVIRONNEMENT PEUVENT JOUER UN RÔLE IMPORTANT POUR RENDRE LE TRAVAIL À DISTANCE PLUS FLUIDE.



POP ACE

Scrivania P. 60 cm. Struttura in metallo verniciato bianco (RAL 9010) e piano in melaminico rovere.

Desk D. 60 cm. White metal structure (RAL 9010) and oak melamine top.

Bureau P. 60 cm. Structure métallique blanche (RAL 9010) et plateau en mélamine chêne.

CLASSE 4 - EM46

Seduta operativa / Task chair / Siège bureau
Rete / Mesh / Résille: Polo - RPG1
Tessuto / Fabric / Tissu: Jet - JTH2



POP WOODY

Scrivania P. 60 cm con struttura in metallo verniciato bianco (RAL 9010) e gamba in frassino naturale verniciato trasparente. Piano in melaminico bianco.

Desk D. 60 cm with white (RAL 9010) metal structure and leg in natural ash, clear varnished. White melamine top.

Bureau P. 60 cm avec structure métallique blanche (RAL 9010) et piétement en frêne naturel verni transparent. Plateau en mélamine blanche.

CLASSE 4 - EM46

Seduta operativa / Task chair / Siège bureau
Rete / Mesh / Résille: Polo - RPZ0
Tessuto / Fabric / Tissu: Jet - JTW2

When Nothing Goes Right, Go Left.

When Nothing Goes Right, Go Left.

When Nothing Goes Right, Go Left.



POP SQUARE

Scrivania con cassetteria ad altezza scrivania. Struttura in metallo verniciato bianco (RAL 9010) e piano in melaminico bianco.

Desk with desk-height pedestal. White (RAL 9010) metal structure and white melamine top.

Bureau avec caisson ht bureau. Structure métallique blanche (RAL 9010) et plateau en mélamine blanche.

CLASSE 4 - EM46

Seduta operativa / Task chair / Siège bureau
Rete / Mesh / Résille: Polo - RPZO
Tessuto / Fabric / Tissu: Jet - JTC1



POP AD

Scrivania elevabile in altezza 1 step (da 73 a 133 cm). Struttura bianca (RAL 9010) e piano in melaminico rovere.

1 step height-adjustable desk (from 75 to 113 cm). White (RAL 9010) metal structure and oak melamine top.

Bureau réglable en hauteur 1 step (de 73 à 113 cm). Structure métallique blanche (RAL 9010) et plateau en mélamine chêne.

DEVA

Seduta direzionale / Executive chair / Siège direction: Boss FR - T4M0

DETTAGLI TECNICI

Technical data/Données techniques

per scrivania

FOR DESK
POUR BUREAU

lid for cable outlet



plastic flap



metal flap



elementi appesi

HANGING ELEMENTS
ÉLÉMENTS SUSPENDU



Cassetto metallico appeso
Hanging metal drawer
Tiroir suspendu en métal



Portacasco/portaborsa e cassetta in metallo
Helmet and bag holders and metal drawer
Porte casque/sac et tiroir en métal



Porta cpu metallico appeso
Hanging metal pc holder
Supporte uc métallique suspendu



Vasca cablaggio per scrivania
Cable tray for desk
Goulotte pour bureau



Raccogliacavi
Cable tray
Passe-cable



Carter salita cavi
Vertical cable duct
Passage câbles



Porta cpu metallico su ruote
Metal pc holder on castors
Support pc en métal sur roulettes



Cassettiera in metallo
Metal pedestal
Caisson en métal



Cassettiera in melaminico
Melamine pedestal
Caisson en mélamine

DETTAGLI TECNICI

Technical data/Données techniques

per tavoli bench

FOR BENCH DESKS
POUR BUREAUX DOUBLES

lid for cable outlet



plastic flap



metal flap



ribs



riba



cover



cablaggio bench

BENCH DESK CABLE MANAGEMENT
CÂBLAGE BUREAU DOUBLE

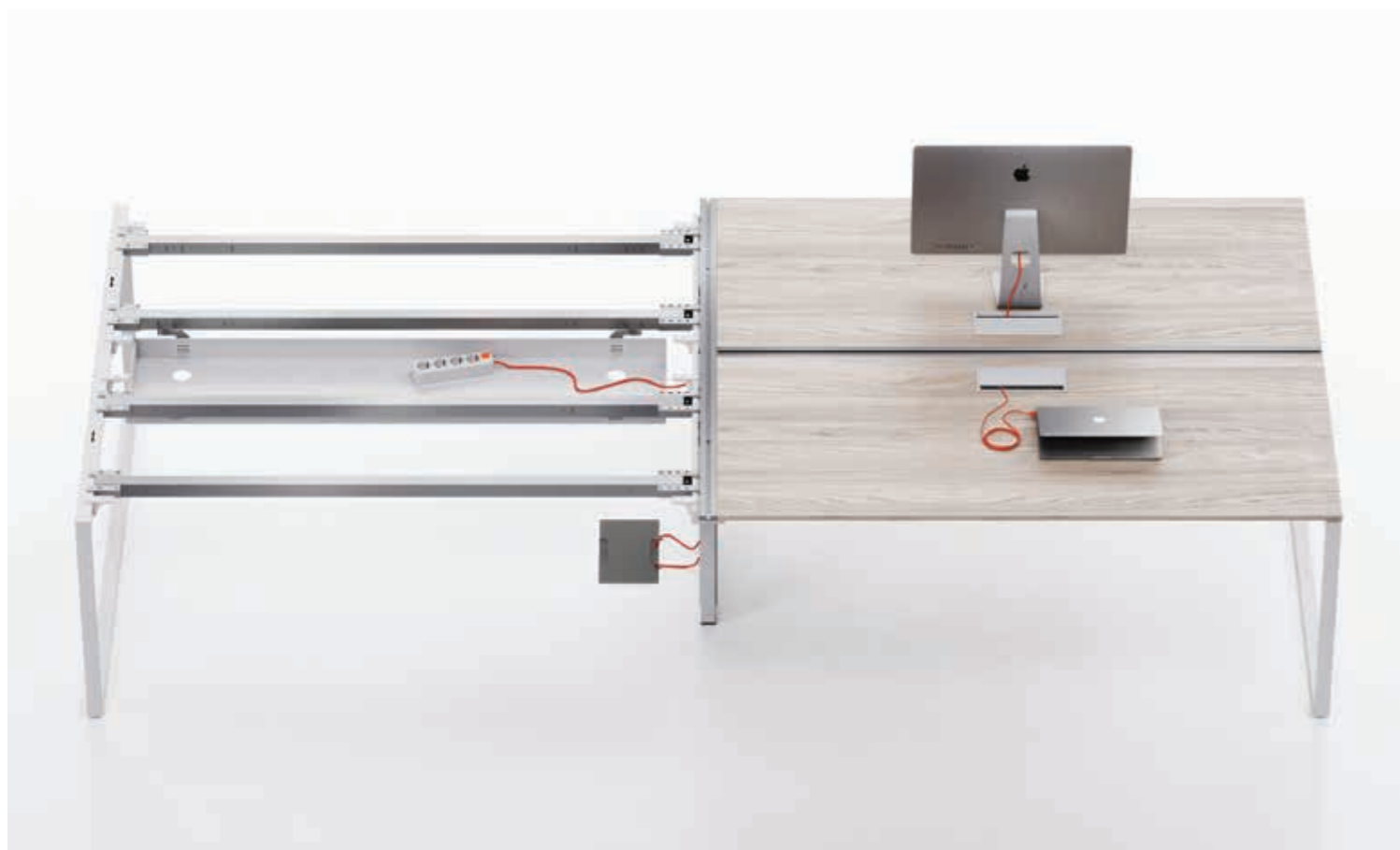

CARTER FOR INTERMEDIATE LEG

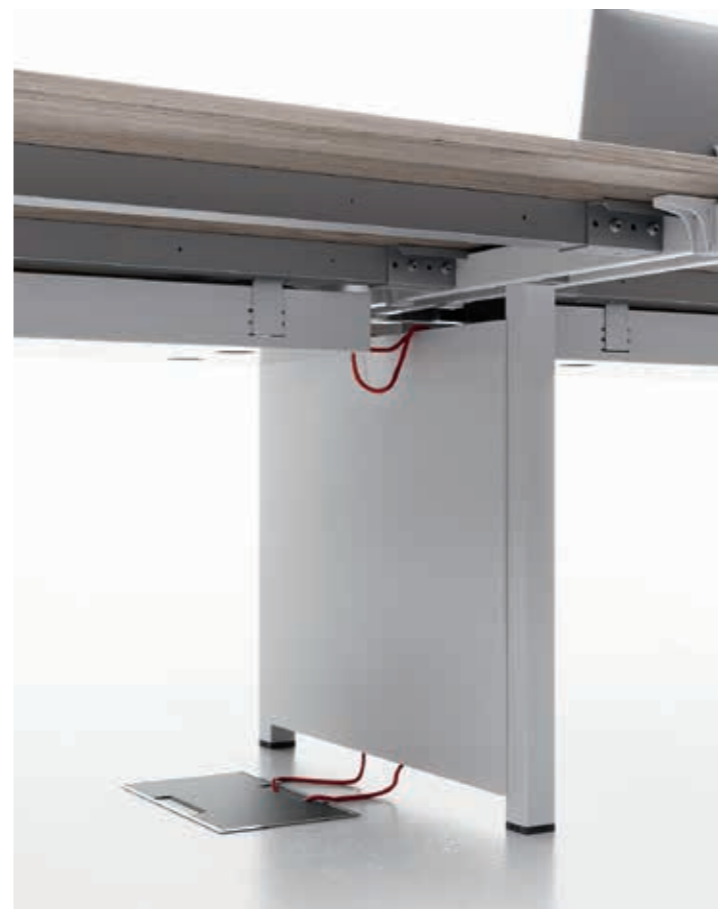

Vasca cablaggio regolabile in altezza con tappi di chiusura
Height-adjustable cable tray with closing lids
Goulotte réglable en hauteur avec bouchons de fermeture



Regolazione in altezza (H. 12,5 cm ÷ 15,4 cm)
Adjustable in height (H. 12,5 cm ÷ 15,4 cm)
Réglable en hauteur (Ht. 12,5 cm ÷ 15,4 cm)

DETTAGLI TECNICI

Technical data/Données techniques

schermi

SCREENS
PANNEAUX-ÉCRAN



Melaminico
Melamine
Mélamine



Tessuto
Fabric
Tissu



Vetro
Glass
Verre

Accessori per schermi con barra reggiaccessori

ACCESSORIES FOR SCREENS WITH ACCESSORY BAR
ACCESSOIRES POUR PANNEAUX ÉCRAN AVEC BARRE PORTE-ACCESSOIRES



Barra reggiaccessori per schermo in melaminico/tessuto
Accessory bar for melamine/fabric screen
Barre porte-accessoires pour panneau écran en mélamine/tissu

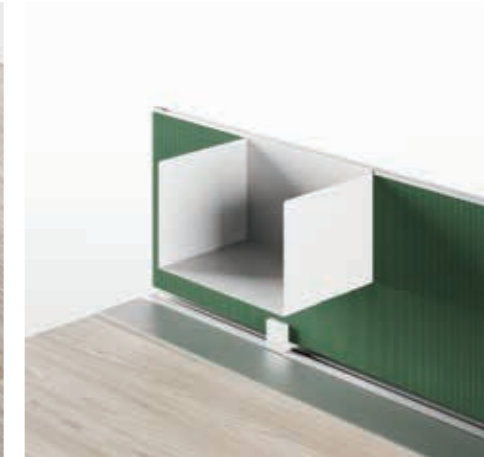

Supporto porta dox
Support for file boxes
Support pour classeur



Supporto porta dox + mensola
Support for file boxes + shelf
Support pour classeur + étagère



Vaschetta porta cancelleria
Stationery tray
Bac plumier



Vaschetta porta fogli A4
Size A4 paper tray
Bac à feuilles format A4



Vaschetta porta oggetti
Objects tray
Bac plumier

DETTAGLI TECNICI

Technical data/Données techniques

Mobili di servizio portanti

SUPPORTING SERVICE CABINETS
MEUBLES DE SERVICE PORTANTS

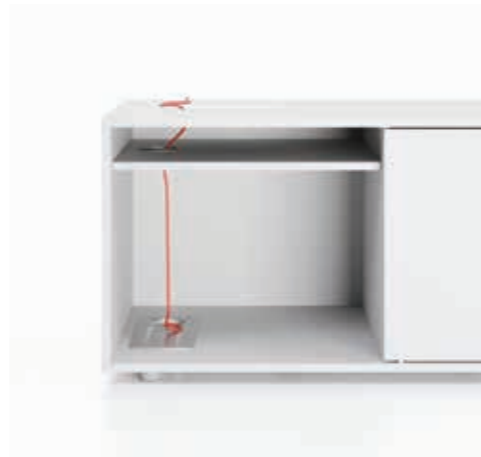

Accessori per mobili di servizio portanti

ACCESSORIES FOR SUPPORTING SERVICE CABINETS
ACCESSOIRES POUR MEUBLES DE SERVICE PORTANTS



Ripiano spostabile per mobili di servizio portanti L. 120 cm
Movable shelf for supporting service cabinets W. 120 cm
Étagère amovible pour meubles de service portants L. 120 cm



Ripiano spostabile per mobili di servizio portanti L. 165 cm
Movable shelf for supporting service cabinets W. 165 cm
Étagère amovible pour meubles de service portants L. 165 cm



Ripiano spostabile per mobili di servizio portanti double L. 165 cm
Movable shelf for supporting service cabinets double W. 165 cm
Étagère amovible pour meubles de service portants double L. 165 cm



Cuscino per mobili di servizio portanti L. 120 cm
Cushion for supporting service cabinets W. 120 cm
Coussin pour meubles de service portants L. 120 cm



Cuscino per mobili di servizio portanti L. 165 cm
Cushion for supporting service cabinets W. 165 cm
Coussin pour meubles de service portants L. 165 cm



Cassettiera 3 cassetti
Pedestal 3-drawers
Caisson 3 tiroirs



Cassettiera 1 cassetto + 1 classificatore
Pedestal 1 drawer + 1 filing unit
Caisson avec 1 tiroir et 1 tiroir ds



Cassettiera 2 cassetti
Pedestal 2-drawers
Caisson 2 tiroirs

DETTAGLI TECNICI

Technical data/Données techniques

sistemi di cablaggio

WIRE MANAGEMENT SYSTEM
SYSTÈME DE GESTION DE CÂBLES



FINITURE
Finishes / Finitions

FINITURE
FINISHES/FINITIONS

pop woody

pop easy / square / ace

struttura

STRUCTURE
STRUCTURE

metal



BI WHITE
RAL 9010

solid wood



TRANSPARENT
VARNISHED
NATURAL ASH

metal



NE BLACK
RAL 9005

solid wood



TRANSPARENT
VARNISHED
NATURAL ASH

piano

TOP
PLATEAU

melamine



MBI WHITE



MTR DOVE



MCE CONCRETE
TEXTURED EFFECT



MOB LIGHT ELM



MRO OAK



MNT AMERICAN
WALNUT



MNE BLACK

gonna

MODESTY PANEL
VOILE DE FOND

melamine



MBI WHITE



MTR DOVE



MCE CONCRETE
TEXTURED EFFECT



MOB LIGHT ELM



MRO OAK



MNT AMERICAN
WALNUT



MNE BLACK

vasca di cablaggio

CABLE TRAY
GOULOTTE

metal



BI WHITE
RAL 9010



NE BLACK
RAL 9005

schermi

SCREENS
Panneaux-Écran

melamine

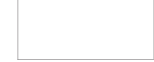

MBI WHITE



MTR DOVE

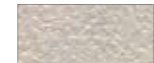

MCE CONCRETE
TEXTURED EFFECT



MOB LIGHT ELM



MRO OAK



MNT AMERICAN
WALNUT

glass



VØC FROSTED GLASS

fabric



Cat. D
King Flex



Cat. F
Jet

FINITURE

FINISHES/FINITIONS

struttura

STRUCTURE
STRUCTURE

metal



BI WHITE
RAL 9010

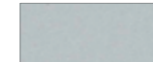

AS ALUMINIUM
RAL 9006



NE BLACK
RAL 9005

piano

TOP
PLATEAU

melamine



MBI WHITE



MTR DOVE

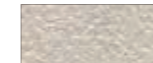

MCE CONCRETE
TEXTURED EFFECT



MOB LIGHT ELM



MRO OAK



MNT AMERICAN
WALNUT



MOL ELM
ONLY FOR
EASY-SQUARE

gonna

MODESTY PANEL
VOILE DE FOND

melamine



MBI WHITE



MTR DOVE

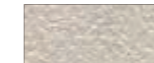

MCE CONCRETE
TEXTURED EFFECT



MOB LIGHT ELM



MRO OAK



MNT AMERICAN
WALNUT



MNE BLACK



MOL ELM
ONLY FOR
EASY-SQUARE

vasca di cablaggio

CABLE TRAY
GOULOTTE

metal



BI WHITE
RAL 9010

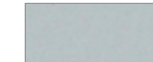

AS SILK ALUMINIUM
RAL 9006



NE BLACK
RAL 9005

schermi

SCREENS
Panneaux-Écran

melamine



MBI WHITE



MTR DOVE

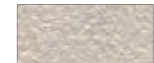

MCE CONCRETE
TEXTURED EFFECT



MOB LIGHT ELM



MRO OAK



MNT AMERICAN
WALNUT



MOL ELM
ONLY FOR
EASY-SQUARE

glass



VØC FROSTED GLASS

fabric



Cat. D
King Flex



Cat. F
Jet

pop easy



pop square



pop ace



FINITURE

FINISHES/FINITIONS

struttura

STRUCTURE
STRUCTURE

metal



BI WHITE
RAL 9010

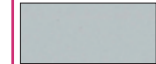

AS SILK ALUMINIUM
RAL 9006

piano

TOP
PLATEAU

melamine



MBI WHITE



MGT ICE GREY



MRO OAK



MNT AMERICAN
WALNUT

vasca di cablaggio

CABLE TRAY
GOULOTTE

metal



BI WHITE
RAL 9010



AS SILK ALUMINIUM
RAL 9006

schermi

SCREENS
PANNEAUX-ÉCRAN

melamine



MBI WHITE

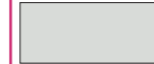

MGT ICE GREY



MRO OAK



MNT AMERICAN
WALNUT

fabric



Cat. D
King Flex



Cat. F
Jet

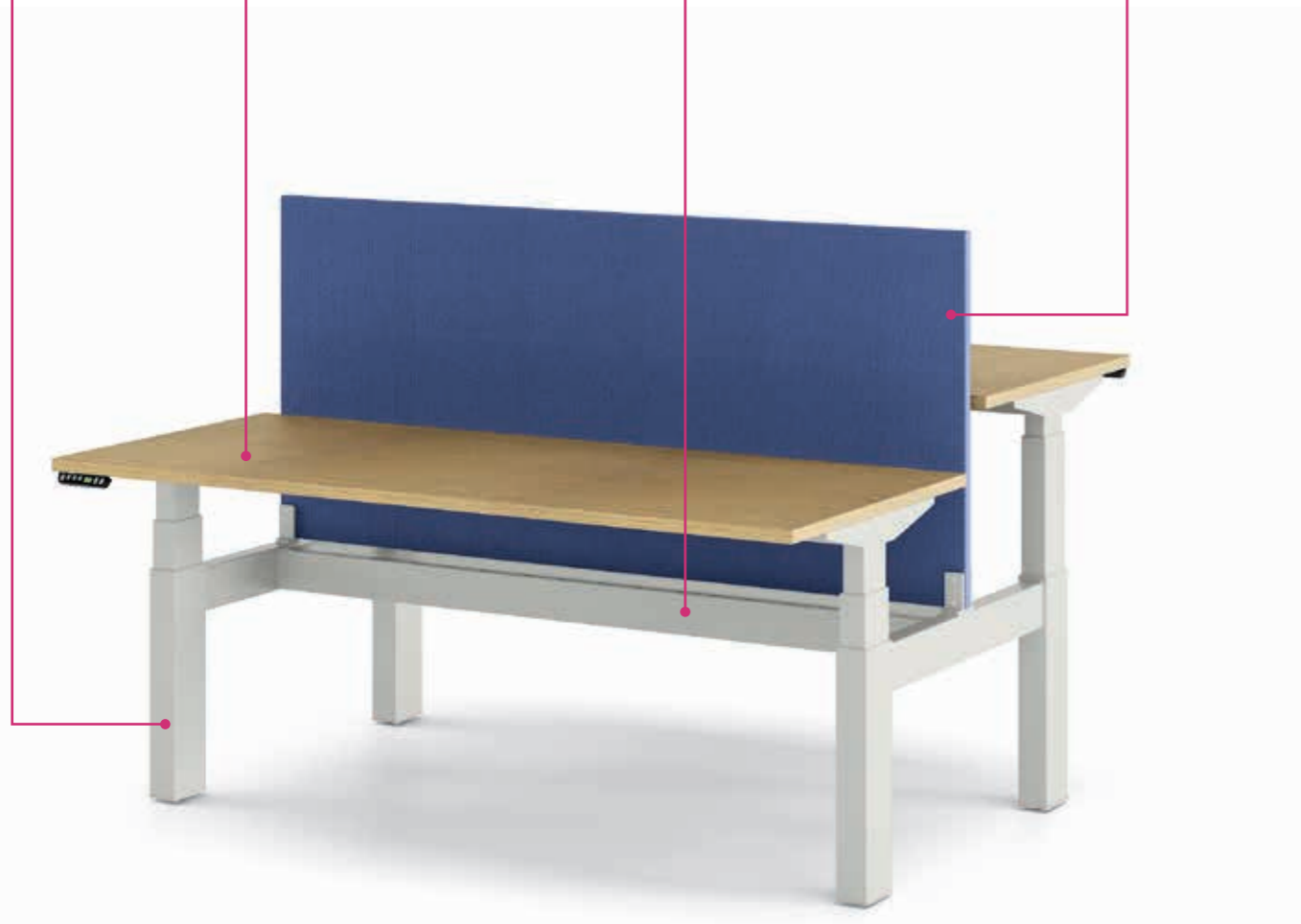

FINITURE

FINISHES/FINITIONS

struttura

STRUCTURE
STRUCTURE

metal



BI WHITE
RAL 9010



AS SILK ALUMINIUM
RAL 9006

piano

TOP
PLATEAU

melamine



MBI WHITE

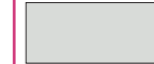

MGT ICE GREY



MRO OAK



MNT AMERICAN
WALNUT

gonna

MODESTY PANEL
VOILE DE FOND

melamine



MBI WHITE

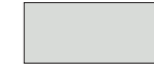

MGT ICE GREY



MRO OAK



MNT AMERICAN
WALNUT



piani/gambe

TOP/LEGS
PLATEAU/PIETEMENTS

melamine



MBI WHITE

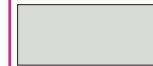

MGT ICE GREY

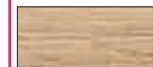

MRO OAK



MNT AMERICAN WALNUT

gonna

MODESTY PANEL
VOILE DE FOND

melamine



MBI WHITE

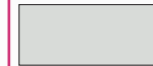

MGT ICE GREY



MRO OAK



MNT AMERICAN WALNUT

vasca cablaggio

CABLE TRAY
GOULOTTE

metal



BI WHITE
RAL 9010

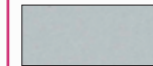

AS ALUMINIUM
RAL 9006



NE BLACK
RAL 9005

schermi

SCREENS
PANNEAUX-ÉCRAN

melamine



MBI WHITE



MGT ICE GREY



MRO OAK



MNT AMERICAN WALNUT

glass



VOC FROSTED GLASS

fabric



Cat. D
King Flex



Cat. F
Jet

struttura

STRUCTURE
STRUCTURE

metal



BI WHITE
RAL 9010



AS ALUMINIUM
RAL 9006



NE BLACK
RAL 9005

piano

TOP
PLATEAU

melamine



MBI WHITE



MGT ICE GREY



MRO OAK



MNT AMERICAN WALNUT

gonna

MODESTY PANEL
VOILE DE FOND

melamine



MBI WHITE

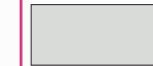

MGT ICE GREY



MRO OAK



MNT AMERICAN WALNUT

vasca cablaggio

CABLE TRAY
GOULOTTE

metal



BI WHITE
RAL 9010

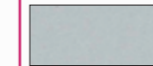

AS ALUMINIUM
RAL 9006



NE BLACK
RAL 9005

schermi

SCREENS
PANNEAUX-ÉCRAN

melamine



MBI WHITE

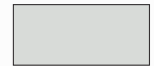

MGT ICE GREY



MRO OAK

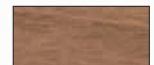

MNT AMERICAN WALNUT

glass



VOC FROSTED GLASS

fabric



Cat. D
King Flex



Cat. F
Jet

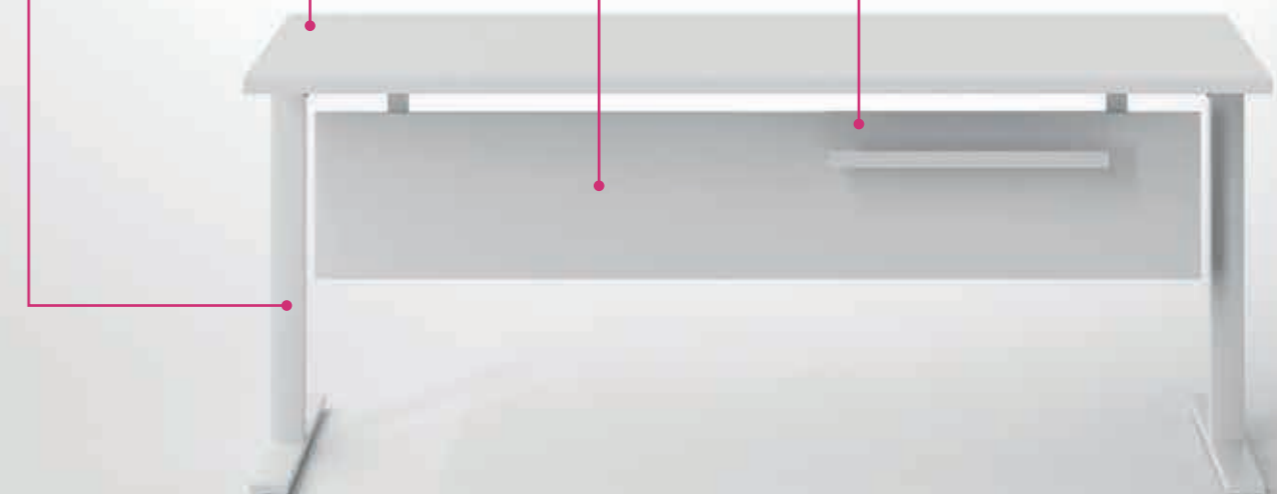

FINITURE

FINISHES/FINITIONS

struttura

STRUCTURE
STRUCTURE

metal



BI WHITE
RAL 9010

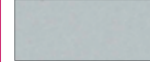

AS ALUMINIUM
RAL 9006



NE BLACK
RAL 9005



CR POLISHED
CHROME

piano

TOP
PLATEAU

melamine th.18 mm



MBI WHITE

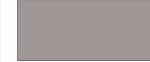

MTR DOVE



MNE BLACK

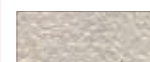

MCE CONCRETE
TEXTURED EFFECT



MOB LIGHT ELM



MRO OAK



MNT AMERICAN WALNUT



MRC TOBACCO OAK



MOL ELM

melamine th.28 mm



MBI WHITE

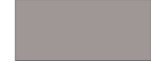

MTR DOVE

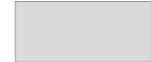

MGT ICE GREY



MOB LIGHT ELM



MRO OAK



MNT AMERICAN WALNUT



MRC TOBACCO OAK



MOL ELM

melamine th.38 mm



MBI WHITE

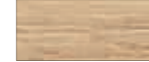

MRO OAK



MNT AMERICAN WALNUT



MRC TOBACCO OAK



MOL ELM

glass th.12 mm



VOC FROSTED

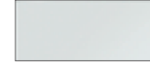

VBI WHITE



VTR DOVE



VNE BLACK



struttura

STRUCTURE
STRUCTURE

metal



BI WHITE
RAL 9010



NE BLACK
RAL 9005



CR POLISHED
CHROME

piano

TOP
PLATEAU

melamine th.18 mm



MBI WHITE

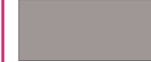

MTR DOVE



MNE BLACK

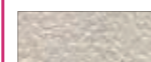

MCE CONCRETE
TEXTURED EFFECT



MOB LIGHT ELM



MRO OAK



MNT AMERICAN WALNUT



MRC TOBACCO OAK



MOL ELM

melamine th.28 mm



MBI WHITE

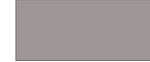

MTR DOVE

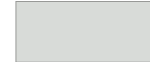

MGT ICE GREY



MOB LIGHT ELM



MRO OAK



MNT AMERICAN WALNUT



MRC TOBACCO OAK



MOL ELM



FINITURE

FINISHES/FINITIONS

struttura

STRUCTURE
STRUCTURE

metal



BI WHITE
RAL 9010

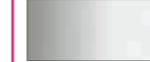

CR POLISHED
CHROME

piano

TOP
PLATEAU

melamine th.18 mm



MBI WHITE

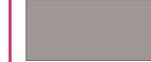

MTR DOVE



MNE BLACK

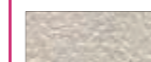

MCE CONCRETE
TEXTURED EFFECT



MOB LIGHT ELM



MRO OAK



MNT AMERICAN WALNUT



MRC TOBACCO OAK



MOL ELM

melamine th.28 mm



MBI WHITE

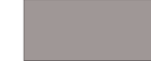

MTR DOVE

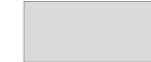

MGT ICE GREY



MOB LIGHT ELM



MRO OAK



MNT AMERICAN WALNUT



MRC TOBACCO OAK



MOL ELM



struttura

STRUCTURE
STRUCTURE

melamine



MBI WHITE

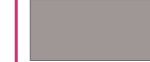

MTR DOVE

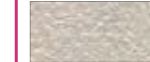

MCE CONCRETE
TEXTURED EFFECT



MOB LIGHT ELM



MRO OAK



MNT AMERICAN WALNUT



MOL ELM

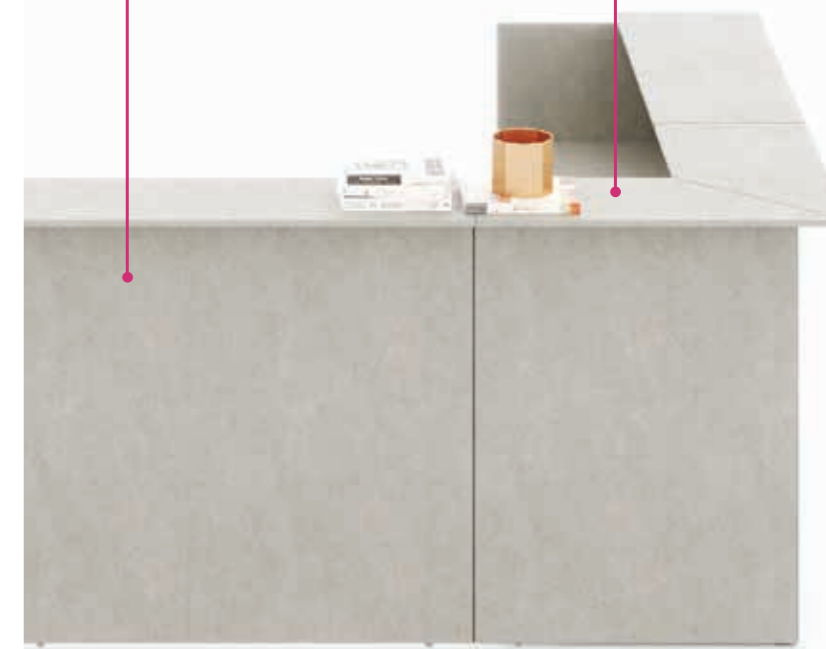

top

TOP
PLATEAU

melamine



MBI WHITE

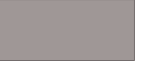

MTR DOVE

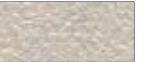

MCE CONCRETE
TEXTURED EFFECT



MOB LIGHT ELM



MRO OAK



MNT AMERICAN WALNUT



MOL ELM

DATI TECNICI POP

TECHNICAL DATA/DONNÉES TECHNIQUES



<p>__0508 L80 P80 H74</p> <p>__0510 L100 P80 H74</p> <p>__0512 L120 P80 H74</p> <p>__0514 L140 P80 H74</p> <p>__0516 L160 P80 H74</p> <p>__0518 L180 P80 H74</p> <p>__0520 L200 P80 H74</p>	<p>__1408 L80 P60 H74</p> <p>__1410 L100 P60 H74</p> <p>__1412 L120 P60 H74</p> <p>__1414 L140 P60 H74</p> <p>__1416 L160 P60 H74</p> <p>__1418 L180 P60 H74</p>	<p>__5514 L140 P80 H74</p> <p>__5516 L160 P80 H74</p> <p>__5518 L180 P80 H74</p> <p>__5520 L200 P80 H74</p>	<p>__1554 L140 P80 H74</p> <p>__1556 L160 P80 H74</p> <p>__1558 L180 P80 H74</p> <p>__1560 L200 P80 H74</p>	<p>__3564 L140 P80 H74</p> <p>__3566 L160 P80 H74</p> <p>__3568 L180 P80 H74</p> <p>__3570 L200 P80 H74</p>
<p>__0408 L80 P60 H74</p> <p>__0410 L100 P60 H74</p> <p>__0412 L120 P60 H74</p> <p>__0414 L140 P60 H74</p> <p>__0416 L160 P60 H74</p> <p>__0418 L180 P60 H74</p>	<p>EA1428 L80 P42 H74</p> <p>EA1430 L100 P42 H74</p> <p>EA1432 L120 P42 H74</p>			



<p>__4512 L120 P165 H74</p> <p>__4514 L140 P165 H74</p> <p>__4516 L160 P165 H74</p> <p>__4518 L180 P165 H74</p> <p>__4520 L200 P165 H74</p>	<p>__4532 (120) L240 P165 H74</p> <p>__4534 (140) L280 P165 H74</p> <p>__4536 (160) L320 P165 H74</p> <p>__4538 (180) L360 P165 H74</p> <p>__4540 (200) L400 P165 H74</p>	<p>__6512B L120 P165 H74</p> <p>__6514B L140 P165 H74</p> <p>__6516B L160 P165 H74</p> <p>__6518B L180 P165 H74</p> <p>__6520B L200 P165 H74</p>	<p>EA6512IN L120 P165 H74</p> <p>EA6514IN L140 P165 H74</p> <p>EA6516IN L160 P165 H74</p> <p>EA6518IN L180 P165 H74</p> <p>EA6520IN L200 P165 H74</p>	<p>__6512F L120 P165 H74</p> <p>__6514F L140 P165 H74</p> <p>__6516F L160 P165 H74</p> <p>__6518F L180 P165 H74</p> <p>__6520F L200 P165 H74</p>	<p>__4410 L100 P125 H74</p> <p>__4412 L120 P125 H74</p> <p>__4414 L140 P125 H74</p> <p>__4416 L160 P125 H74</p> <p>__4418 L180 P125 H74</p>	<p>__4430 (100) L200 P125 H74</p> <p>__4432 (120) L240 P125 H74</p> <p>__4434 (140) L280 P125 H74</p> <p>__4436 (160) L320 P125 H74</p> <p>__4438 (180) L360 P125 H74</p>	<p>__6310B L100 P125 H74</p> <p>__6312B L120 P125 H74</p> <p>__6314B L140 P125 H74</p> <p>__6316B L160 P125 H74</p> <p>__6318B L180 P125 H74</p>	<p>EA6310IN L100 P125 H74</p> <p>EA6312IN L120 P125 H74</p> <p>EA6314IN L140 P125 H74</p> <p>EA6316IN L160 P125 H74</p> <p>EA6318IN L180 P125 H74</p>	<p>__6310F L100 P125 H74</p> <p>__6312F L120 P125 H74</p> <p>__6314F L140 P125 H74</p> <p>__6316F L160 P125 H74</p> <p>__6318F L180 P125 H74</p>		



<p>__0538 L180 P90 H74</p> <p>__0540 L200 P90 H74</p>	<p>__1430 L100 P60 H74</p>	<p>__5538 L180 P90 H74</p> <p>__5540 L200 P90 H74</p>	<p>PA1578 L180 P90 H74</p> <p>PA1580 L200 P90 H74</p>	<p>PA3588 L180 P90 H74</p> <p>PA3590 L200 P90 H74</p>



<p>__4712 L120 P165 H74</p> <p>__4714 L140 P165 H74</p> <p>__4716 L160 P165 H74</p> <p>__4718 L180 P165 H74</p> <p>__4720 L200 P165 H74</p>	<p>__4732 L240 P165 H74</p> <p>__4734 L280 P165 H74</p> <p>__4736 L320 P165 H74</p> <p>__4738 L360 P165 H74</p> <p>__4740 L400 P165 H74</p>	<p>__8512B L120 P165 H74</p> <p>__8514B L140 P165 H74</p> <p>__8516B L160 P165 H74</p> <p>__8518B L180 P165 H74</p> <p>__8520B L200 P165 H74</p>	<p>EA8512IN L120 P165 H74</p> <p>EA8514IN L140 P165 H74</p> <p>EA8516IN L160 P165 H74</p> <p>EA8518IN L180 P165 H74</p> <p>EA8520IN L200 P165 H74</p>	<p>__8512F L120 P165 H74</p> <p>__8514F L140 P165 H74</p> <p>__8516F L160 P165 H74</p> <p>__8518F L180 P165 H74</p> <p>__8520F L200 P165 H74</p>							

accessori

Accessories
Accessoires

<p>Modesty panel</p> <p>PE0310 L80 P1,8 H30</p> <p>PE0312 L100 P1,8 H30</p> <p>PE0314 L120 P1,8 H30</p> <p>PE0316 L140 P1,8 H30</p> <p>PE0318 L160 P1,8 H30</p> <p>PE0320 L180 P1,8 H30</p>	<p>Closing panel for pop easy leg</p> <p>EA9206 (60) x1</p> <p>EA9208 (80) x1</p>	<p>Closing panel for pop square leg</p> <p>PQ9206 (60) x1</p> <p>PQ9208 (80) x1</p> <p>PQ9213 (125) x1</p> <p>PQ9217 (165) x1</p>	<p>Desk pad</p> <p>TG9508 L80 P50 H0,3</p>

<p>__1717 L165 P165 H74</p> <p>__1613 L125 P125 H74</p> <p>__1614 L140 P125 H74</p> <p>__1616 L160 P125 H74</p> <p>__1618 L180 P125 H74</p> <p>__1620 L200 P125 H74</p> <p>__1622 L220 P125 H74</p>	<p>__1624 L240 P125 H74</p>	<p>__1733 (165) L330 P165 H74</p>	<p>__1628 (140) L280 P125 H74</p> <p>__1632 (160) L320 P125 H74</p> <p>__1636 (180) L360 P125 H74</p> <p>__1644 (220) L440 P125 H74</p>	<p>EA2712N L120 P165 H74</p> <p>EA2714N L140 P165 H74</p> <p>EA2716N L160 P165 H74</p> <p>EA2717N L165 P165 H74</p> <p>EA2718N L180 P165 H74</p>	<p>EA2612N L120 P125 H74</p> <p>EA2614N L140 P125 H74</p> <p>EA2616N L160 P125 H74</p> <p>EA2618N L180 P125 H74</p>			

DATI TECNICI POP

TECHNICAL DATA/DONNÉES TECHNIQUES

schermi per scrivania/bench

Screens for desk/bench desk
Panneaux écran pour bureau/bureau double

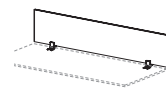

melamine

PPS110M	L100	P1,8	H38,5
PPS112M	L120	P1,8	H38,5
PPS114M	L140	P1,8	H38,5
PPS116M	L160	P1,8	H38,5
PPS118M	L180	P1,8	H38,5
PPS120M	L200	P1,8	H38,5

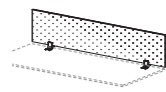

fabric upholstered

PPS110T	L100	P2	H38,5
PPS112T	L120	P2	H38,5
PPS114T	L140	P2	H38,5
PPS116T	L160	P2	H38,5
PPS118T	L180	P2	H38,5
PPS120T	L200	P2	H38,5

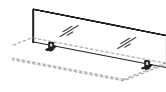

glass

PPS110V	L100	P0,6	H38,5
PPS112V	L120	P0,6	H38,5
PPS114V	L140	P0,6	H38,5
PPS116V	L160	P0,6	H38,5
PPS118V	L180	P0,6	H38,5
PPS120V	L200	P0,6	H38,5



melamine

PPS610M	L100	P1,8	H38,5
PPS612M	L120	P1,8	H38,5
PPS613M	L125	P1,8	H38,5
PPS614M	L140	P1,8	H38,5
PPS616M	L160	P1,8	H38,5
PPS618M	L180	P1,8	H38,5
PPS620M	L200	P1,8	H38,5

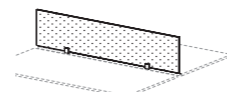

fabric upholstered

PPS610T	L100	P2	H38,5
PPS612T	L120	P2	H38,5
PPS613T	L125	P2	H38,5
PPS614T	L140	P2	H38,5
PPS616T	L160	P2	H38,5
PPS618T	L180	P2	H38,5
PPS620T	L200	P2	H38,5

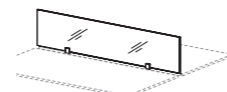

glass

PPS610V	L100	P0,6	H38,5
PPS612V	L120	P0,6	H38,5
PPS613V	L125	P0,6	H38,5
PPS614V	L140	P0,6	H38,5
PPS616V	L160	P0,6	H38,5
PPS618V	L180	P0,6	H38,5
PPS620V	L200	P0,6	H38,5

guard screen - schermi

Screens
Panneaux écran



melamine

DSPP110M	L100	P1,8	H60
DSPP112M	L120	P1,8	H60
DSPP114M	L140	P1,8	H60



glass

DSPP110V	L100	P0,6	H60
DSPP112V	L120	P0,6	H60
DSPP114V	L140	P0,6	H60

schermo laterale

Side screen
Panneau écran latéral

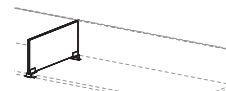

melamine

PPS738M	L80	P1,8	H38,5
---------	-----	------	-------

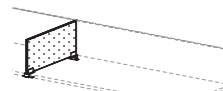

fabric upholstered

PPS738T	L80	P2	H38,5
---------	-----	----	-------



melamine

PPS808M	L80	P1,8	H38,5
PPS817M	L165	P1,8	H38,5
PPS813M	L125	P1,8	H38,5

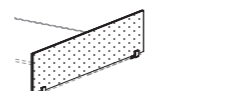

fabric upholstered

PPS808T	L80	P2	H38,5
PPS817T	L165	P2	H38,5
PPS813T	L125	P2	H38,5



glass

PPS808V	L80	P0,6	H38,5
PPS817V	L165	P0,6	H38,5
PPS813V	L125	P0,6	H38,5

elettificazione

Wiring elements
Electrification

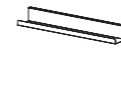

Cable tray for desk

PP9205	L50	P11	H8
PP9207	L70	P11	H8



Cable tray for bench desk

PE9270	(100)	L80	P15	H9
PE9272	(120)	L100	P15	H9
PE9274	(140)	L120	P15	H9
PE9276	(160)	L140	P15	H9
PE9278	(180)	L160	P15	H9
PE9280	(200)	L180	P15	H9

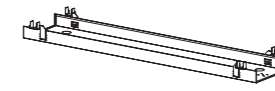

Cable tray for bench desk

PE9218	(80)	L60	P34	H12 ÷ 15
PE9220	(100)	L80	P34	H12 ÷ 15
PE9222	(120)	L100	P34	H12 ÷ 15
PE9224	(140)	L120	P34	H12 ÷ 15
PE9226	(160)	L140	P34	H12 ÷ 15
PE9228	(180)	L160	P34	H12 ÷ 15
PE9230	(200)	L180	P34	H12 ÷ 15



2 caps for bench desk cable tray

PP9209	L34	P1	H7
--------	-----	----	----

barra reggiaccessori per schermo in melaminico/tessuto

Accessory bar for melamine/fabric upholstered screen
Barre porte-accessoires pour panneau écran en mélamine/tissu

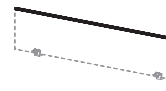

PPF110	L100	P1,9	H38,5
PPF112	L120	P1,9	H38,5
PPF113	L125	P1,9	H38,5
PPF114	L140	P1,9	H38,5
PPF116	L160	P1,9	H38,5
PPF117	L165	P1,9	H38,5
PPF118	L180	P1,9	H38,5
PPF120	L200	P1,9	H38,5

accessori per schermi con barra reggiaccessori

Accessories for screens with accessory bar
Accessoires pour panneaux écran avec barre porte-accessoires

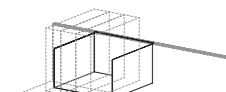

CR9555 L33 P23 H20

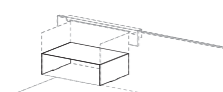

only for CR9555
CR9560 L33 P23 H10

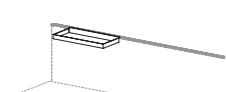

CR9558 L30 P10 H2,5

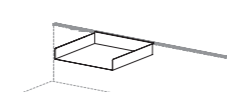

CR9559 L33 P23 H5

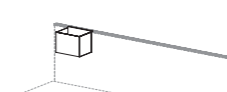

CR9556 L13 P10 H10



Cover

PE9510	L100	P3	H2
PE9512	L120	P3	H2
PE9514	L140	P3	H2
PE9516	L160	P3	H2
PE9518	L180	P3	H2
PE9520	L200	P3	H2

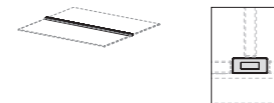

Central metal profile

PE9248	L80	P5	H2
PE9250	L100	P5	H2
PE9252	L120	P5	H2
PE9253	L125	P5	H2
PE9254	L140	P5	H2
PE9256	L160	P5	H2
PE9257	L165	P5	H2
PE9258	L180	P5	H2
PE9260	L200	P5	H2

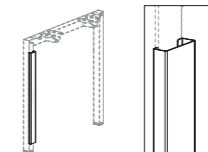

Carter for leg

PT9201	L5	P3	H56
--------	----	----	-----



Carter for intermediate leg

PE9208	(80)	L17	P5	H59
PE9213	(125)	L22	P5	H59
PE9217	(165)	L66	P5	H59



Cable duct

PO9230	H84
PO9232	H140



CPU Holder

PCPU01	L22	P50	H56
--------	-----	-----	-----



CPU Holder

PCPU21	L26	P49	H59
--------	-----	-----	-----

DATI TECNICI POP

TECHNICAL DATA/DONNÉES TECHNIQUES

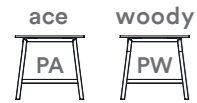

tavoli H. 105 cm

tables H. 105 cm
tables Ht. 105 cm

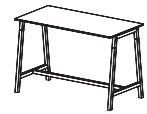

_0562 L120 P80 H105
_0564 L140 P80 H105
_0566 L160 P80 H105
_0568 L180 P80 H105



_1654 L140 P125 H105
_1656 L160 P125 H105
_1658 L180 P125 H105
_1660 L200 P125 H105

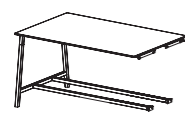

_1674 L140 P125 H105
_1676 L160 P125 H105
_1678 L180 P125 H105
_1680 L200 P125 H105

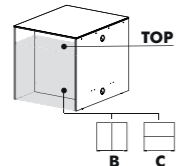

CS0960 L104 P125 H105

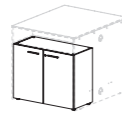

B
AF13102 L100 P46 H80

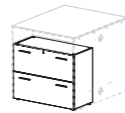

C
AF13143M L100 P46 H80

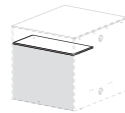

TOP
AFTB121F L100 P46 H1,8

accessori per tavolo H. 105 cm

Accessories for tables H. 105 cm
Accessoires pour tables Ht. 105 cm



Cable duct
PO9232 H140

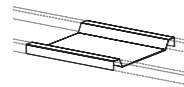

Bag holder
PA9201 L50 P50 H5



Bag hook
PA9501 L5 P7 H6

tavoli circolari

Round tables
Tables circulaires



PA1750 Ø100 H74
PA1752 Ø120 H74
PA1754 Ø140 H74
PA1756 Ø160 H74
PA1758 Ø180 H74



PW1750 Ø100 H74
PW1752 Ø120 H74
PW1754 Ø140 H74
PW1756 Ø160 H74
PW1758 Ø180 H74

pop tables

Tables
Tables



VR908 Ø 80 H74
VR910 Ø 100H74
VR912 Ø 120H74



VR928 Ø 80 H74
VR930 Ø 100H74
VR932 Ø 120H74



VR938 L80 P80 H74
VR940 L100 P100 H74

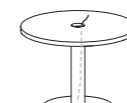

VR918 Ø 80 H74
VR920 Ø 100H74
VR922 Ø 120H74



VR908V Ø 80 H74
VR910V Ø 100H74
VR912V Ø 120H74



VR928V Ø 80 H74
VR930V Ø 100H74
VR932V Ø 120H74



CS1726 Ø 60 H75 ÷ 113



CS1736 L60 P60 H75 ÷ 113



CS1746 Ø 60 H88 ÷ 125



CS1756 L60 P60 H88 ÷ 125

baguette - bancone reception

Counter for desk
Comptoir d'accueil

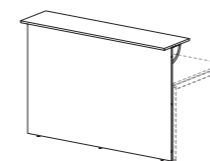

TBF12 L120 P40 H110
TBF14 L140 P40 H110
TBF16 L160 P40 H110
TBF18 L180 P40 H110
TBF20 L200 P40 H110

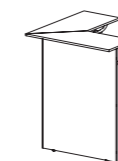

TBFA80 L93 P93 H110

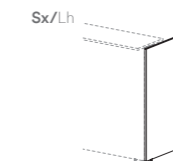

Sx/Lh TBF7 L62 P1,8 H107
Dx/Rh TBF6 L62 P1,8 H107

Sx/Lh TBF9 L82 P1,8 H107
Dx/Rh TBF8 L82 P1,8 H107

DATI TECNICI POP

TECHNICAL DATA/DONNÉES TECHNIQUES

ad

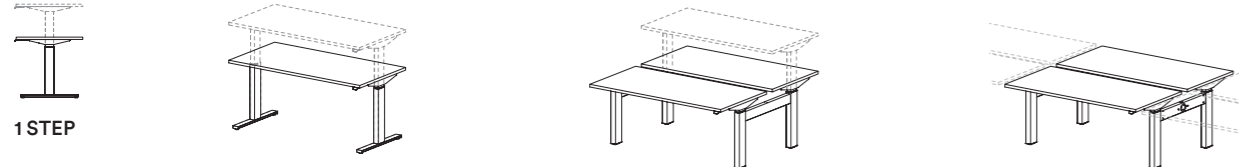

1 STEP

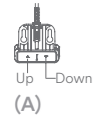

PO05121A	L120	P80	H73 ÷ 113
PO05141A	L140	P80	H73 ÷ 113
PO05161A	L160	P80	H73 ÷ 113
PO05181A	L180	P80	H73 ÷ 113
PO04121A	L120	P60	H73 ÷ 113
PO04141A	L140	P60	H73 ÷ 113
PO04161A	L160	P60	H73 ÷ 113
PO04181A	L180	P60	H73 ÷ 113

FREESTANDING/STARTING Bench DESK

PO45121A	L120	P170	H73 ÷ 113
PO45141A	L140	P170	H73 ÷ 113
PO45161A	L160	P170	H73 ÷ 113
PO45181A	L180	P170	H73 ÷ 113

MIDDLE/FINAL Bench DESK

PO65121A	L120	P170	H73 ÷ 113
PO65141A	L140	P170	H73 ÷ 113
PO65161A	L160	P170	H73 ÷ 113
PO65181A	L180	P170	H73 ÷ 113

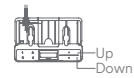

PO05121B	L120	P80	H73 ÷ 113
PO05141B	L140	P80	H73 ÷ 113
PO05161B	L160	P80	H73 ÷ 113
PO05181B	L180	P80	H73 ÷ 113
PO04121B	L120	P60	H73 ÷ 113
PO04141B	L140	P60	H73 ÷ 113
PO04161B	L160	P60	H73 ÷ 113
PO04181B	L180	P60	H73 ÷ 113

FREESTANDING/STARTING Bench DESK

PO45121B	L120	P170	H73 ÷ 113
PO45141B	L140	P170	H73 ÷ 113
PO45161B	L160	P170	H73 ÷ 113
PO45181B	L180	P170	H73 ÷ 113

MIDDLE/FINAL Bench DESK

PO65121B	L120	P170	H73 ÷ 113
PO65141B	L140	P170	H73 ÷ 113
PO65161B	L160	P170	H73 ÷ 113
PO65181B	L180	P170	H73 ÷ 113

ad

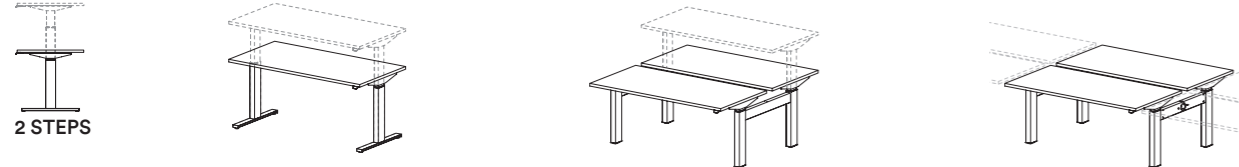

2 STEPS

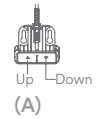

PO05122A	L120	P80	H65 ÷ 125
PO05142A	L140	P80	H65 ÷ 125
PO05162A	L160	P80	H65 ÷ 125
PO05182A	L180	P80	H65 ÷ 125
PO04122A	L120	P60	H65 ÷ 125
PO04142A	L140	P60	H65 ÷ 125
PO04162A	L160	P60	H65 ÷ 125
PO04182A	L180	P60	H65 ÷ 125

FREESTANDING/STARTING Bench DESK

PO45122A	L120	P170	H65 ÷ 125
PO45142A	L140	P170	H65 ÷ 125
PO45162A	L160	P170	H65 ÷ 125
PO45182A	L180	P170	H65 ÷ 125

MIDDLE/FINAL Bench DESK

PO65122A	L120	P170	H65 ÷ 125
PO65142A	L140	P170	H65 ÷ 125
PO65162A	L160	P170	H65 ÷ 125
PO65182A	L180	P170	H65 ÷ 125



PO05122B	L120	P80	H65 ÷ 125
PO05142B	L140	P80	H65 ÷ 125
PO05162B	L160	P80	H65 ÷ 125
PO05182B	L180	P80	H65 ÷ 125
PO04122B	L120	P60	H65 ÷ 125
PO04142B	L140	P60	H65 ÷ 125
PO04162B	L160	P60	H65 ÷ 125
PO04182B	L180	P60	H65 ÷ 125

FREESTANDING/STARTING Bench DESK

PO45122B	L120	P170	H65 ÷ 125
PO45142B	L140	P170	H65 ÷ 125
PO45162B	L160	P170	H65 ÷ 125
PO45182B	L180	P170	H65 ÷ 125

MIDDLE/FINAL Bench DESK

PO65122B	L120	P170	H65 ÷ 125
PO65142B	L140	P170	H65 ÷ 125
PO65162B	L160	P170	H65 ÷ 125
PO65182B	L180	P170	H65 ÷ 125

schermi per scrivania

Screens for desk
Panneaux écran pour bureau

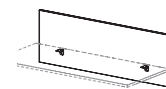

melamine

POS112	L116	P2,8	H60
POS114	L136	P2,8	H60
POS116	L156	P2,8	H60
POS118	L176	P2,8	H60

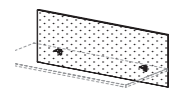

fabric upholstered

POS112	L116	P3	H60
POS114	L136	P3	H60
POS116	L156	P3	H60
POS118	L176	P3	H60

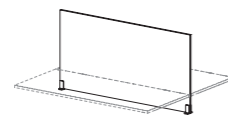

melamine

POS612	L116	P2,8	H80
POS614	L136	P2,8	H80
POS616	L156	P2,8	H80
POS618	L176	P2,8	H80

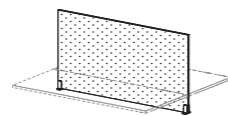

fabric upholstered

POS612	L116	P3	H80
POS614	L136	P3	H80
POS616	L156	P3	H80
POS618	L176	P3	H80



melamine

POS717	L167	P2,8	H80
--------	------	------	-----

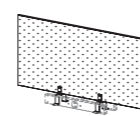

fabric upholstered

POS717	L167	P3	H80
--------	------	----	-----

elettrificazione

Wiring elements
Electrification



Cable tray for desk

PP9205	L50	P11	H8
PP9207	L70	P11	H8



Cable tray for desk

PT9212	(120)	L100	P15	H9
PT9214	(140)	L120	P15	H9
PT9216	(160)	L140	P15	H9
PT9218	(180)	L160	P15	H9



Cable tray for bench desk

PO9211	(120)	L106	P20	H9
PO9213	(140)	L126	P20	H9
PO9215	(160)	L146	P20	H9
PO9217	(180)	L166	P20	H9

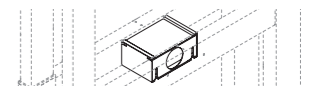

Connecting bracket for bench desk

PO9202	L20	P14	H9
--------	-----	-----	----

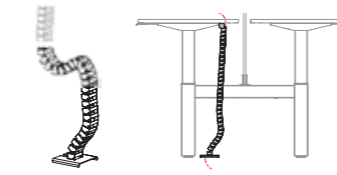

PO9232 H140

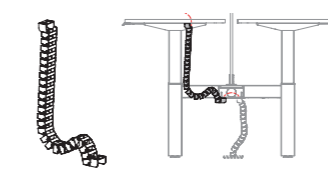

PO9231 H140

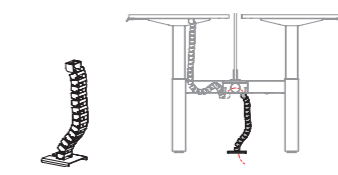

PO9230 H84

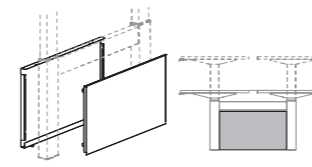

Carter for 1 STEP leg
PO9241 L79 P5 H49

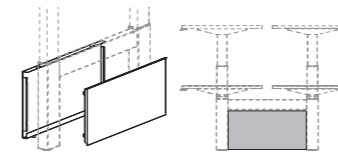

Carter for 2 STEPS leg
PO9240 L78 P5 H40

folding

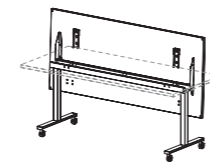

PH0512	L120	P80	H75
PH0514	L140	P80	H75
PH0516	L160	P80	H75
PH0518	L180	P80	H75

PH0412	L120	P60	H75
PH0414	L140	P60	H75
PH0416	L160	P60	H75
PH0418	L180	P60	H75

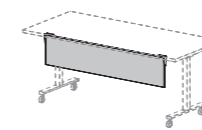

PH0312	(120)	L80	P1,8	H30
PH0314	(140)	L100	P1,8	H30
PH0316	(160)	L120	P1,8	H30
PH0318	(180)	L140	P1,8	H30

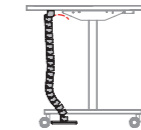

PO9230 H84

DATI TECNICI POP

TECHNICAL DATA/DONNÉES TECHNIQUES

panel

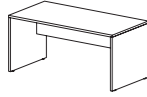

PN0512 L120 P80 H75
 PN0514 L140 P80 H75
 PN0516 L160 P80 H75
 PN0518 L180 P80 H75

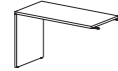

PN1408 L80 P60 H75
 PN1410 L100 P60 H75
 PN1412 L120 P60 H75

PN0408 L80 P60 H75
 PN0410 L100 P60 H75
 PN0412 L120 P60 H75
 PN0414 L140 P60 H75
 PN0416 L160 P60 H75
 PN0418 L180 P60 H75

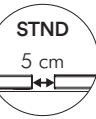

panel

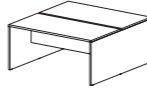

PP4412M L120 P165 H75
 PP4414M L140 P165 H75
 PP4416M L160 P165 H75
 PP4418M L180 P165 H75

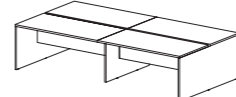

PP4422M (120) L240 P165 H75
 PP4424M (140) L280 P165 H75
 PP4426M (160) L320 P165 H75
 PP4428M (180) L360 P165 H75

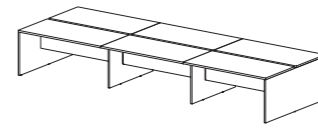

PP4432M (120) L360 P165 H75
 PP4434M (140) L420 P165 H75
 PP4436M (160) L480 P165 H75
 PP4438M (180) L540 P165 H75

panel

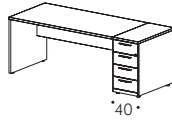

PN0522 L160 P80 H75
 PN0524 L180 P80 H75
 PN0526 L200 P80 H75
 PN0528 L220 P80 H75

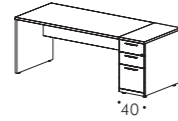

PN0542 L160 P80 H75
 PN0544 L180 P80 H75
 PN0546 L200 P80 H75
 PN0548 L220 P80 H75

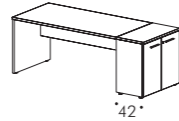

PN0532 L162 P80 H75
 PN0534 L182 P80 H75
 PN0536 L202 P80 H75
 PN0538 L222 P80 H75

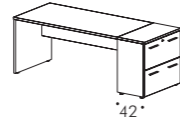

PN0552 L162 P80 H75
 PN0554 L182 P80 H75
 PN0556 L202 P80 H75
 PN0558 L222 P80 H75

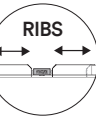

panel

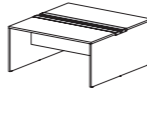

PP4412M L120 P165 H75
 PP4414M L140 P165 H75
 PP4416M L160 P165 H75
 PP4418M L180 P165 H75

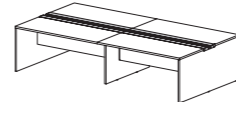

PP4422M (120) L240 P165 H75
 PP4424M (140) L280 P165 H75
 PP4426M (160) L320 P165 H75
 PP4428M (180) L360 P165 H75

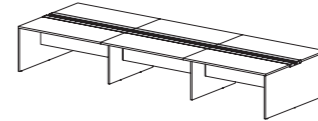

PP4432M (120) L360 P165 H75
 PP4434M (140) L420 P165 H75
 PP4436M (160) L480 P165 H75
 PP4438M (180) L540 P165 H75

panel

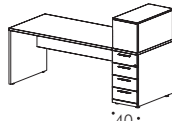

PN0562 L160 P80 H75
 PN0564 L180 P80 H75
 PN0566 L200 P80 H75
 PN0568 L220 P80 H75

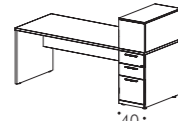

PN0582 L160 P80 H75
 PN0584 L180 P80 H75
 PN0586 L200 P80 H75
 PN0588 L220 P80 H75

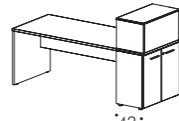

PN0572 L162 P80 H75
 PN0574 L182 P80 H75
 PN0576 L202 P80 H75
 PN0578 L222 P80 H75

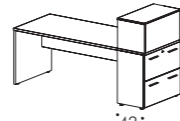

PN0592 L162 P80 H75
 PN0594 L182 P80 H75
 PN0596 L202 P80 H75
 PN0598 L222 P80 H75



panel

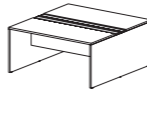

PP4412M L120 P165 H75
 PP4414M L140 P165 H75
 PP4416M L160 P165 H75
 PP4418M L180 P165 H75

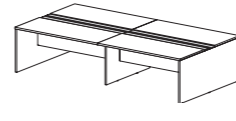

PP4422M (120) L240 P165 H75
 PP4424M (140) L280 P165 H75
 PP4426M (160) L320 P165 H75
 PP4428M (180) L360 P165 H75

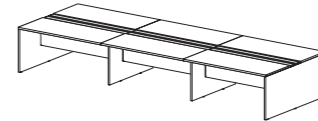

PP4432M (120) L360 P165 H75
 PP4434M (140) L420 P165 H75
 PP4436M (160) L480 P165 H75
 PP4438M (180) L540 P165 H75

panel

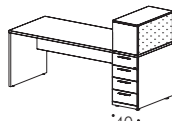

backpanel upholstered in fabric
 PN0562ST L160 P80 H75
 PN0564ST L180 P80 H75
 PN0566ST L200 P80 H75
 PN0568ST L220 P80 H75

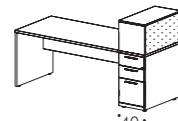

backpanel upholstered in fabric
 PN0582ST L160 P80 H75
 PN0584ST L180 P80 H75
 PN0586ST L200 P80 H75
 PN0588ST L220 P80 H75

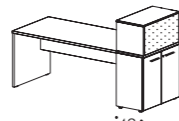

backpanel upholstered in fabric
 PN0572ST L162 P80 H75
 PN0574ST L182 P80 H75
 PN0576ST L202 P80 H75
 PN0578ST L222 P80 H75

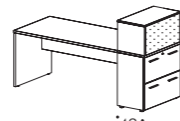

backpanel upholstered in fabric
 PN0592ST L162 P80 H75
 PN0594ST L182 P80 H75
 PN0596ST L202 P80 H75
 PN0598ST L222 P80 H75

elettificazione

Wiring elements
 Electrification



Cable tray for desk
 PP9205 L50 P11 H8
 PP9207 L70 P11 H8



Cable tray for desk
 PT9212 (120) L100 P15 H9
 PT9214 (140) L120 P15 H9
 PT9216 (160) L140 P15 H9
 PT9218 (180) L160 P15 H9



Carter for leg
 TN9203 L6 P3 H53



CPU Holder
 PCPU01 L22 P50 H56



Accessories
 Accessoirs
 PP9208 L80
 PP9206 L60

DATI TECNICI POP

TECHNICAL DATA/DONNÉES TECHNIQUES

tee

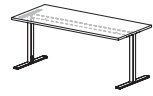

PT0512 L120 P80 H75
 PT0514 L140 P80 H75
 PT0516 L160 P80 H75
 PT0518 L180 P80 H75

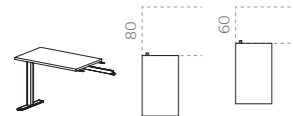

PT1408 L80 P60 H75
 PT1410 L100 P60 H75
 PT1412 L120 P60 H75
 PT1414 L140 P60 H75

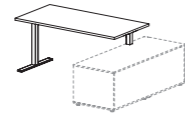

PT1544 L140 P80 H75
 PT1546 L160 P80 H75
 PT1548 L180 P80 H75

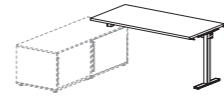

PT1554 L140 P80 H75
 PT1556 L160 P80 H75
 PT1558 L180 P80 H75

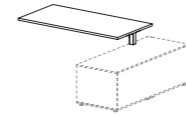

PT2524 L140 P80 H75
 PT2526 L160 P80 H75
 PT2528 L180 P80 H75

PT0408 L80 P60 H75
 PT0410 L100 P60 H75
 PT0412 L120 P60 H75
 PT0414 L140 P60 H75
 PT0416 L160 P60 H75
 PT0418 L180 P60 H75

PT1428 L80 P60 H75
 PT1430 L100 P60 H75

tee

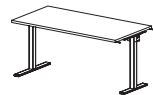

PT1512 L120 P80 H75
 PT1514 L140 P80 H75
 PT1516 L160 P80 H75
 PT1518 L180 P80 H75

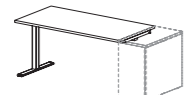

PT1522 L120 P80 H75
 PT1524 L140 P80 H75
 PT1526 L160 P80 H75
 PT1528 L180 P80 H75

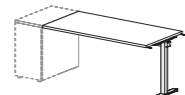

PT1532 L120 P80 H75
 PT1534 L140 P80 H75
 PT1536 L160 P80 H75
 PT1538 L180 P80 H75

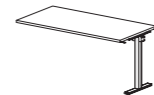

PT2512 L120 P80 H75
 PT2514 L140 P80 H75
 PT2516 L160 P80 H75
 PT2518 L180 P80 H75

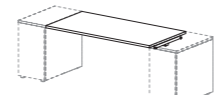

PT3112 L120 P80 H75
 PT3114 L140 P80 H75
 PT3116 L160 P80 H75
 PT3118 L180 P80 H75

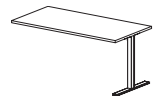

PT3512 L120 P80 H75
 PT3514 L140 P80 H75
 PT3516 L160 P80 H75
 PT3518 L180 P80 H75

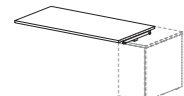

PT4112 L120 P80 H75
 PT4114 L140 P80 H75
 PT4116 L160 P80 H75
 PT4118 L180 P80 H75

accessori

Accessories
 Accessoires

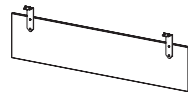

Modesty panel
 PT0310 (100) L80 P1,8 H30
 PT0312 (120) L100 P1,8 H30
 PT0314 (140) L120 P1,8 H30
 PT0316 (160) L140 P1,8 H30
 PT0318 (180) L160 P1,8 H30

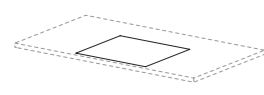

Desk pad
 TG9508 L80 P50 H0,3



CPU Holder
 PCPU01 L22 P50 H56



CPU Holder
 PCPU21 L26 P49 H59

tee



Dx/Rh PT0716 L160 P120 H75
 Sx/Lh PT0715 L160 P120 H75



Dx/Rh PT0726 L160 P120 H75
 Sx/Lh PT0725 L160 P120 H75



Dx/Rh PT0736 L160 P120 H75
 Sx/Lh PT0735 L160 P120 H75

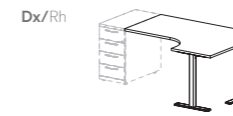

Dx/Rh PT0746 L160 P120 H75
 Sx/Lh PT0745 L160 P120 H75

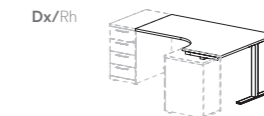

Dx/Rh PT0756 L160 P120 H75
 Sx/Lh PT0755 L160 P120 H75



Dx/Rh PT1716 L160 P120 H75
 Sx/Lh PT1715 L160 P120 H75



Dx/Rh PT1726 L160 P120 H75
 Sx/Lh PT1725 L160 P120 H75

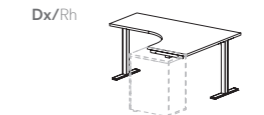

Dx/Rh PT1736 L160 P120 H75
 Sx/Lh PT1735 L160 P120 H75

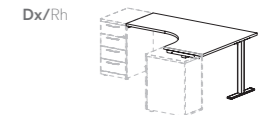

Dx/Rh PT1756 L160 P120 H75
 Sx/Lh PT1755 L160 P120 H75



PT2712 L120 P120 H75
 PT2714 L140 P140 H75



PT2722 L120 P120 H75
 PT2724 L140 P140 H75



PT2732 L120 P120 H75
 PT2734 L140 P140 H75

elettrificazione

Wiring elements
 Electrification



Cable tray for desk
 PP9205 L50 P11 H8
 PP9207 L70 P11 H8



Cable tray for desk
 PT9212 (120) L100 P15 H9
 PT9214 (140) L120 P15 H9
 PT9216 (160) L140 P15 H9
 PT9218 (180) L160 P15 H9

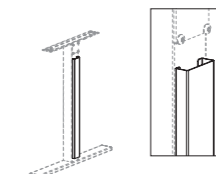

Carter for leg
 PT9201 L5 P3 H56

DATI TECNICI POP

TECHNICAL DATA/DONNÉES TECHNIQUES

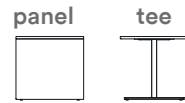

schermi per scrivania/bench

Screens for desk/bench desk
Panneaux écran pour bureau/bureau double

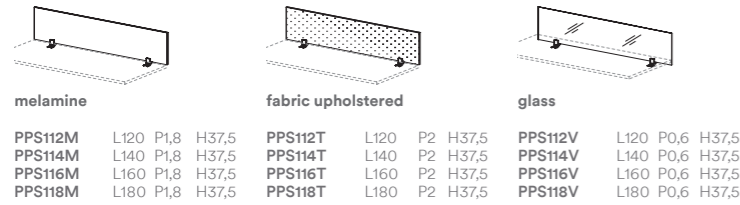

material	model	L	P	H
melamine	PPS112M	L120	P1,8	H37,5
	PPS114M	L140	P1,8	H37,5
	PPS116M	L160	P1,8	H37,5
fabric upholstered	PPS112T	L120	P2	H37,5
	PPS114T	L140	P2	H37,5
	PPS116T	L160	P2	H37,5
glass	PPS112V	L120	P0,6	H37,5
	PPS114V	L140	P0,6	H37,5
	PPS116V	L160	P0,6	H37,5

schermi per bench pop panel con trafilata centrale

Screens with metal profile for bench desk
Panneaux écran avec profil métallique pour bureau double

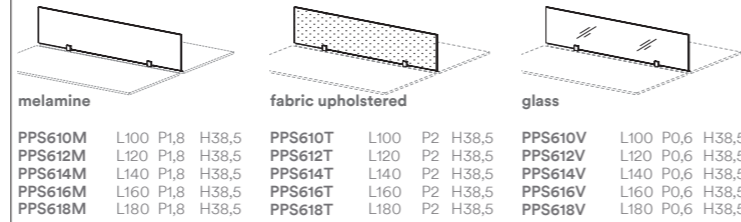

material	model	L	P	H
melamine	PPS610M	L100	P1,8	H38,5
	PPS612M	L120	P1,8	H38,5
	PPS614M	L140	P1,8	H38,5
fabric upholstered	PPS610T	L100	P2	H38,5
	PPS612T	L120	P2	H38,5
	PPS614T	L140	P2	H38,5
glass	PPS610V	L100	P0,6	H38,5
	PPS612V	L120	P0,6	H38,5
	PPS614V	L140	P0,6	H38,5

schermo laterale

Side screen
Panneaux écran latéral

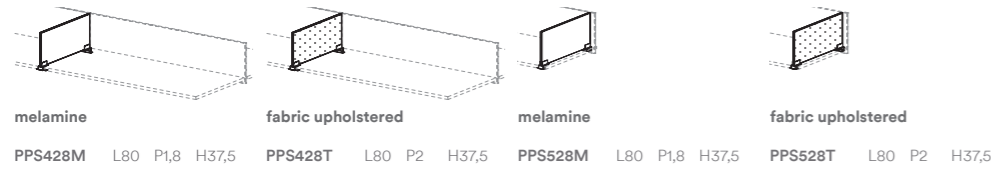

material	model	L	P	H
melamine	PPS428M	L80	P1,8	H37,5
	PPS528M	L80	P1,8	H37,5
fabric upholstered	PPS428T	L80	P2	H37,5
	PPS528T	L80	P2	H37,5

barra reggiaccessori per schermo in melaminico/tessuto

Accessory bar for melamine/fabric screen
Barre porte-accessoires pour panneau écran en mélamine/tissu



PPF110	L100	P2	H1
PPF112	L120	P2	H1
PPF114	L140	P2	H1
PPF116	L160	P2	H1
PPF118	L180	P2	H1

accessori per schermi con barra reggiaccessori

Accessories for screens with accessory bar
Accessoires pour panneaux écran avec barre porte-accessoires

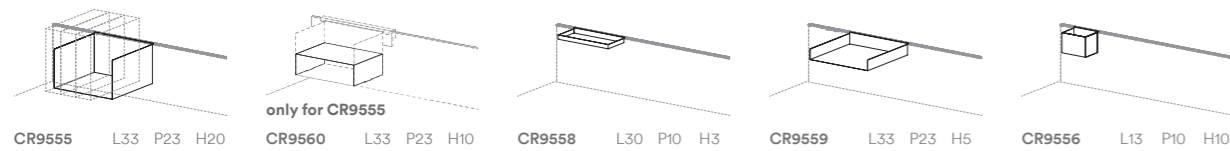

CR9555	L33	P23	H20
CR9560	L33	P23	H10
CR9558	L30	P10	H3
CR9559	L33	P23	H5
CR9556	L13	P10	H10

tavoli riunione

Meeting tables
Tables réunion

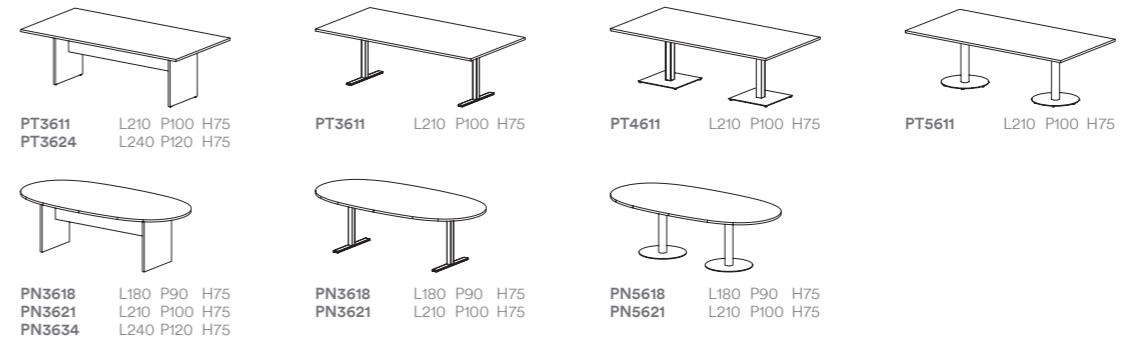

PT3611 PT3624	L210 L240	P100 P120	H75
PT3611	L210	P100	H75
PT4611	L210	P100	H75
PT5611	L210	P100	H75
PN3618 PN3621 PN3634	L180 L210 L240	P90 P100 P120	H75
PN3618 PN3621	L180 L210	P90 P100	H75
PN5618 PN5621	L180 L210	P90 P100	H75

cassettiere ed elementi di servizio su ruote

Pedestals and service units on castors
Caissons et meubles de service sur roulettes

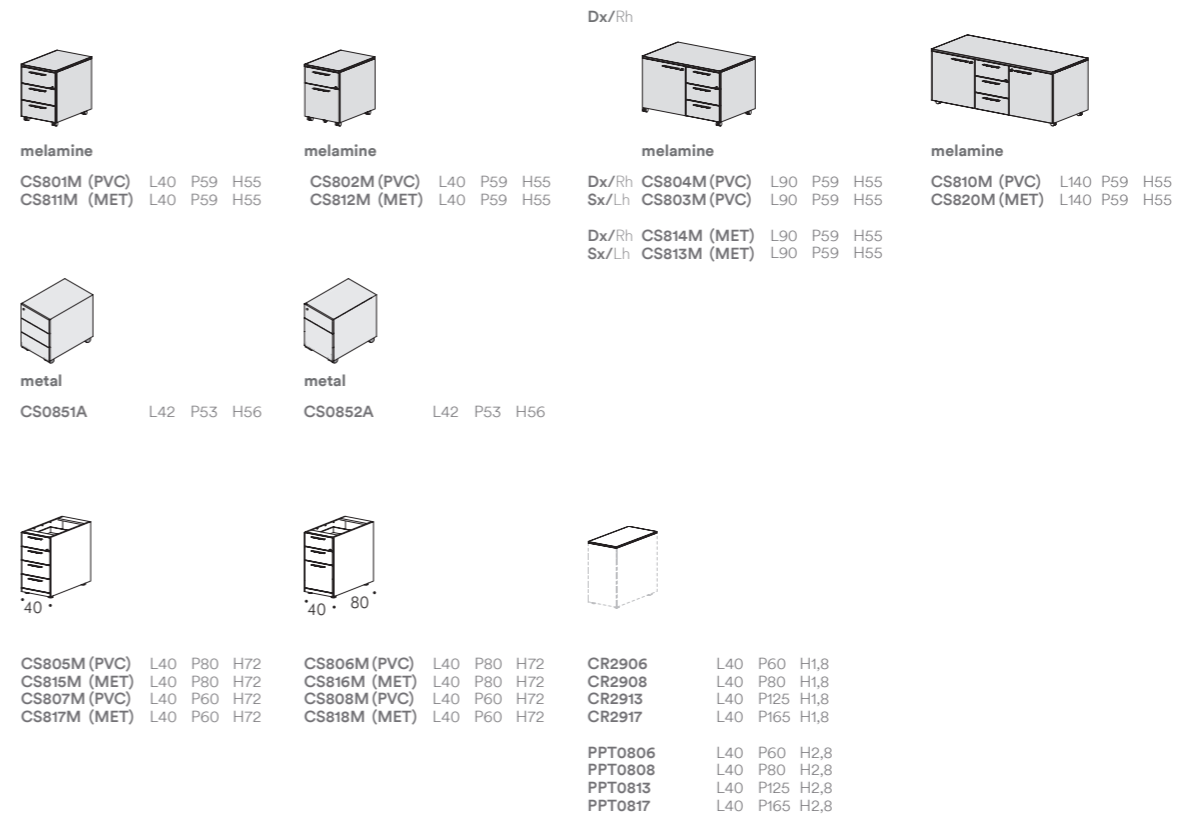

material	model	L	P	H
melamine	CS801M (PVC)	L40	P59	H55
	CS811M (MET)	L40	P59	H55
melamine	CS802M (PVC)	L40	P59	H55
	CS812M (MET)	L40	P59	H55
melamine	Dx/Rh CS804M (PVC)	L90	P59	H55
	Sx/Lh CS803M (PVC)	L90	P59	H55
melamine	Dx/Rh CS814M (MET)	L90	P59	H55
	Sx/Lh CS813M (MET)	L90	P59	H55
metal	CS0851A	L42	P53	H56
	CS0852A	L42	P53	H56
PVC	CS805M	L40	P80	H72
	CS815M (MET)	L40	P80	H72
	CS807M (PVC)	L40	P60	H72
	CS817M (MET)	L40	P60	H72
MET	CS806M (PVC)	L40	P80	H72
	CS816M (MET)	L40	P80	H72
	CS808M (PVC)	L40	P60	H72
	CS818M (MET)	L40	P60	H72
PVC	CR2906	L40	P60	H1,8
	CR2908	L40	P80	H1,8
	CR2913	L40	P125	H1,8
	CR2917	L40	P165	H1,8
MET	PPT0806	L40	P60	H2,8
	PPT0808	L40	P80	H2,8
	PPT0813	L40	P125	H2,8
	PPT0817	L40	P165	H2,8

pedestals

DATI TECNICI

TECHNICAL DATA/DONNÉES TECHNIQUES



elementi appesi

Hanging elements
Eléments suspendu

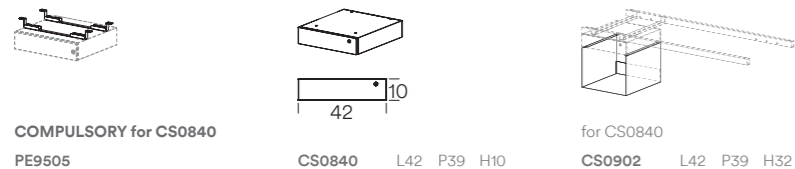

COMPULSORY for CS0840

PE9505

CS0840 L42 P39 H10

for CS0840

CS0902 L42 P39 H32



mobile di servizio

service unit
meuble de service

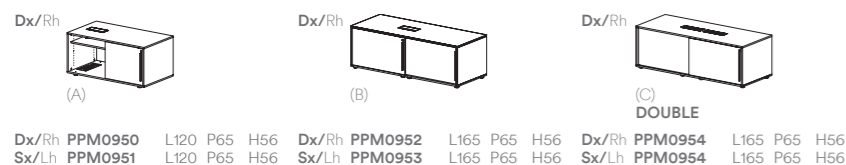

Dx/Rh PPM0950 L120 P65 H56
Sx/Lh PPM0951 L120 P65 H56

Dx/Rh PPM0952 L165 P65 H56
Sx/Lh PPM0953 L165 P65 H56

Dx/Rh PPM0954 L165 P65 H56
Sx/Lh PPM0954 L165 P65 H56

accessori per mobile di servizio

Accessories for service unit
Accessoires pour meuble de service

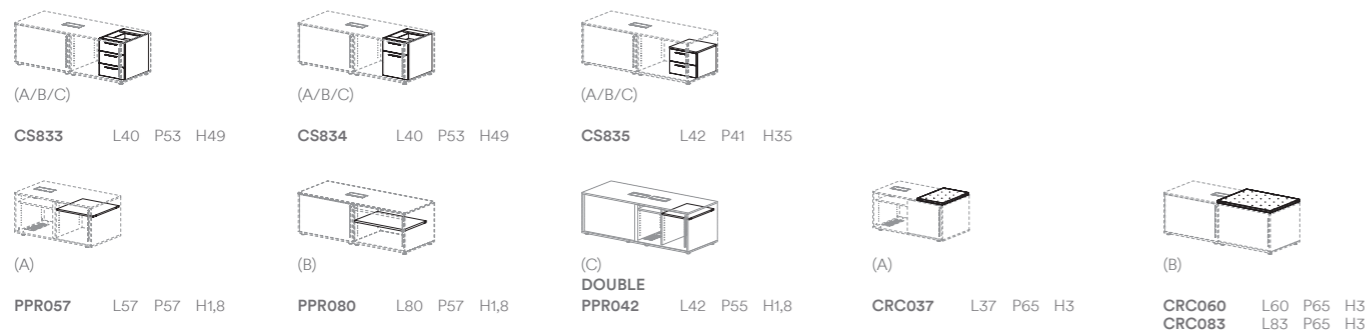

CS833 L40 P53 H49

CS834 L40 P53 H49

CS835 L42 P41 H35

PPR057 L57 P57 H1,8

PPR080 L80 P57 H1,8

PPR042 L42 P55 H1,8

CRC037 L37 P65 H3

CRC060 L60 P65 H3
CRC083 L83 P65 H3



allunghi appesi con cassettera h. scrivania

Hanging extension with desk-height pedestal
Retour suspendu avec caisson ht bureau

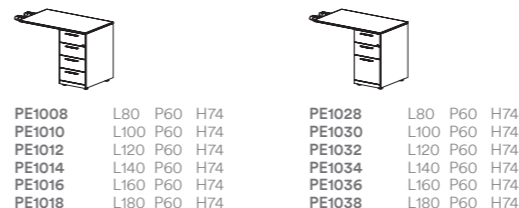

PE1008 L80 P60 H74
PE1010 L100 P60 H74
PE1012 L120 P60 H74
PE1014 L140 P60 H74
PE1016 L160 P60 H74
PE1018 L180 P60 H74

PE1028 L80 P60 H74
PE1030 L100 P60 H74
PE1032 L120 P60 H74
PE1034 L140 P60 H74
PE1036 L160 P60 H74
PE1038 L180 P60 H74

panel



allunghi appesi con cassettera h. scrivania

Hanging extension with desk-height pedestal
Retour suspendu avec caisson ht bureau

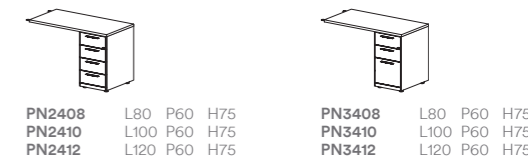

PN2408 L80 P60 H75
PN2410 L100 P60 H75
PN2412 L120 P60 H75

PN3408 L80 P60 H75
PN3410 L100 P60 H75
PN3412 L120 P60 H75



cassettiere h. scrivania

Pedestal h. desk
Caisson ht bureau

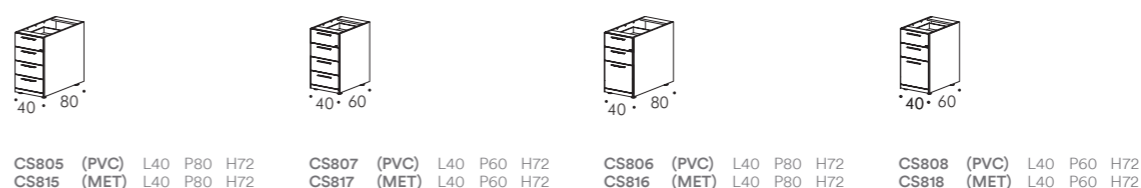

CS805 (PVC) L40 P80 H72
CS815 (MET) L40 P80 H72

CS807 (PVC) L40 P60 H72
CS817 (MET) L40 P60 H72

CS806 (PVC) L40 P80 H72
CS816 (MET) L40 P80 H72

CS808 (PVC) L40 P60 H72
CS818 (MET) L40 P60 H72



CR2906 L40 P60 H1,8
CR2908 L40 P80 H1,8
CR2913 L40 P125 H1,8
CR2917 L40 P165 H1,8

COVER
PE9201 L5 P3 H70

CS0938 L80 P40 H42

fabric upholstered backpanel
CS0938T L80 P40 H42

PPT0806 L40 P60 H2,8
PPT0808 L40 P80 H2,8
PPT0813 L40 P125 H2,8
PPT0817 L40 P165 H2,8

orgatower

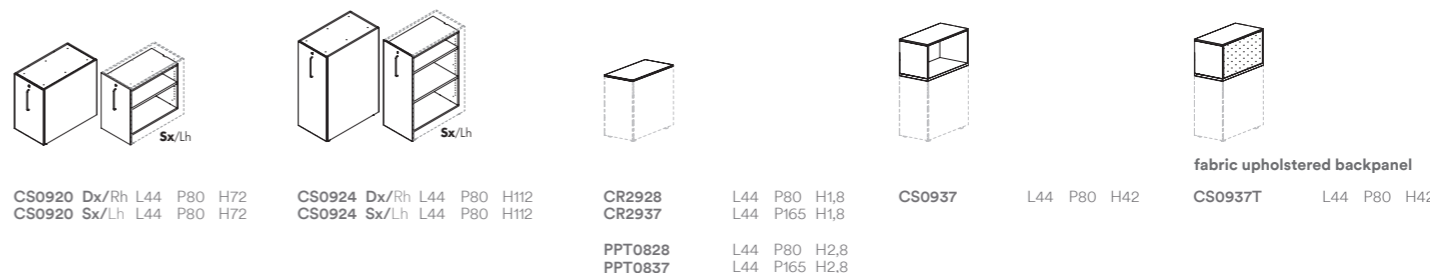

CS0920 Dx/Rh L44 P80 H72
CS0920 Sx/Lh L44 P80 H72

CS0924 Dx/Rh L44 P80 H112
CS0924 Sx/Lh L44 P80 H112

CR2928 L44 P80 H1,8
CR2937 L44 P165 H1,8

CS0937 L44 P80 H42

fabric upholstered backpanel
CS0937T L44 P80 H42

PPT0828 L44 P80 H2,8
PPT0837 L44 P165 H2,8

DATI TECNICI

TECHNICAL DATA/DONNÉES TECHNIQUES



armadi ad altezza scrivania

Desk-height cabinets
Armoires Ht. bureau

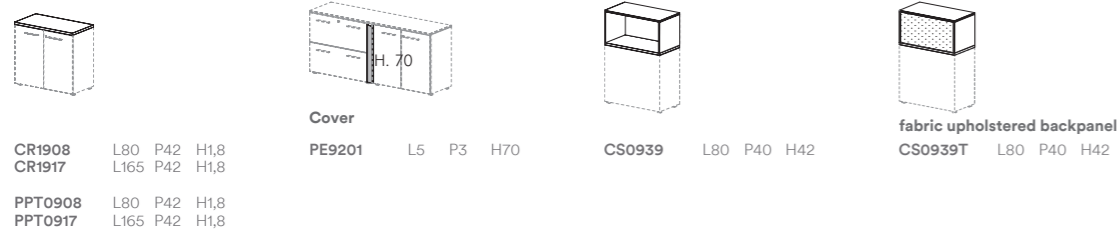

cabinets

cabinets SP01 - 1SIDE

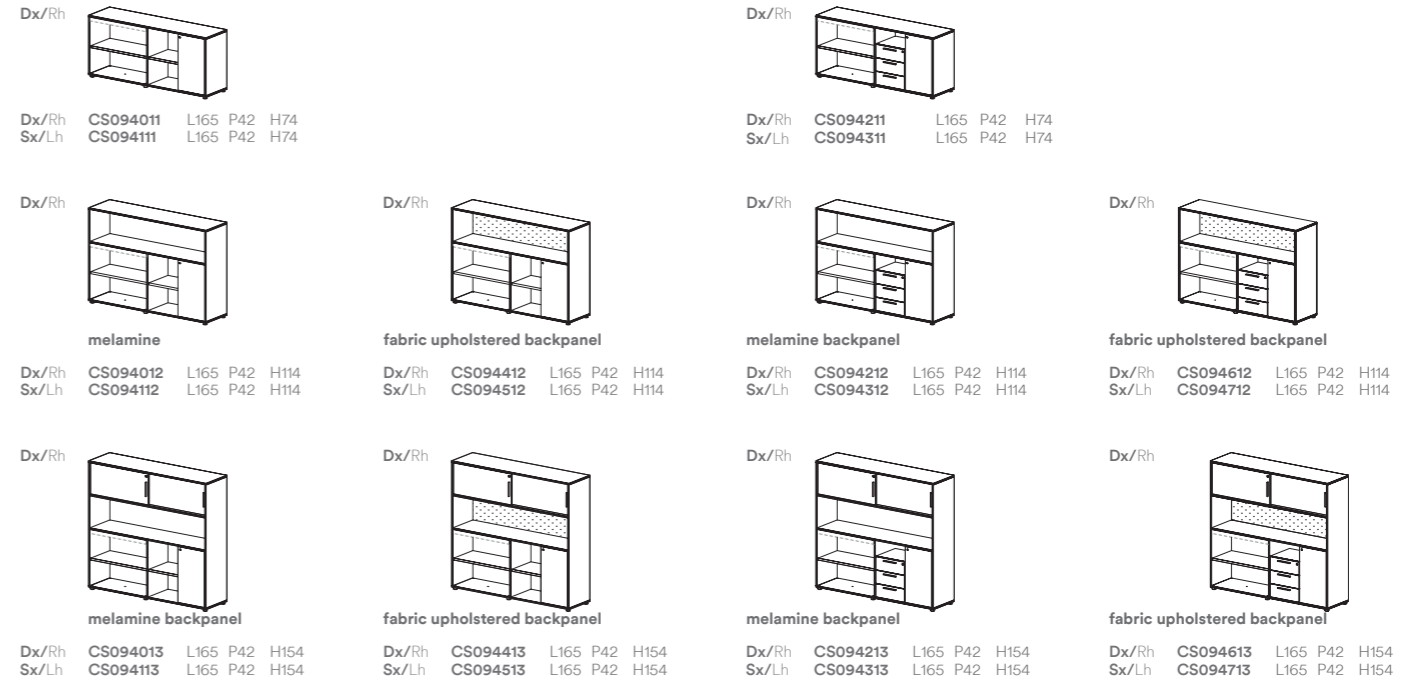
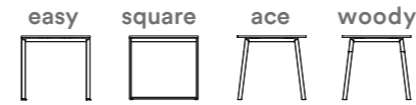

armadi con ante scorrevoli

Cabinets with sliding doors
Armoires avec portes coulissantes

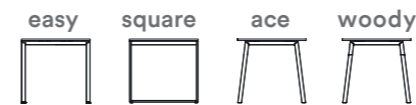
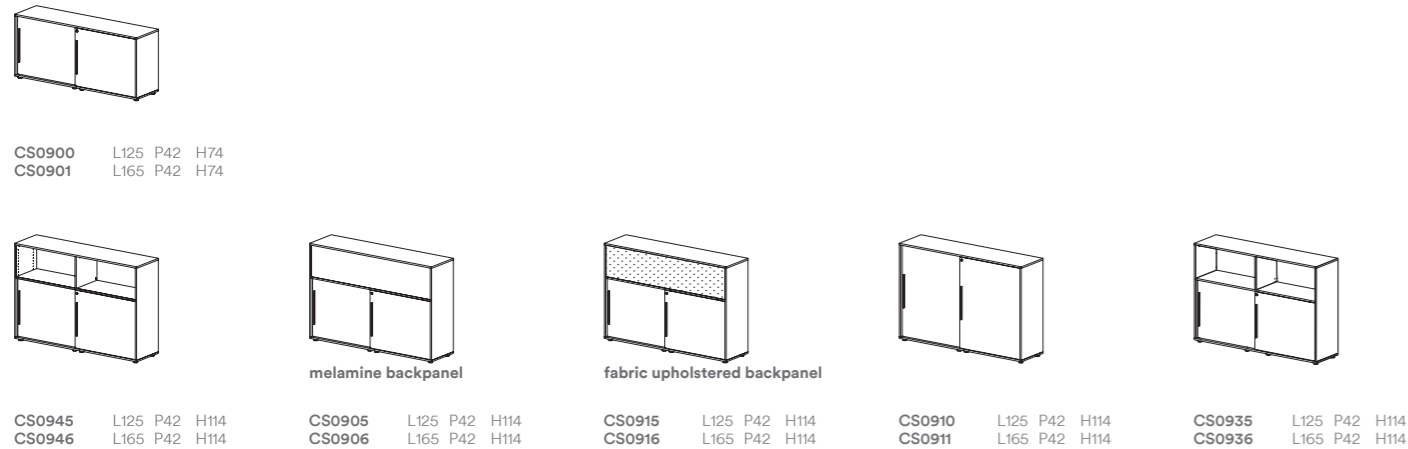

cabinets SP02 - 2SIDES

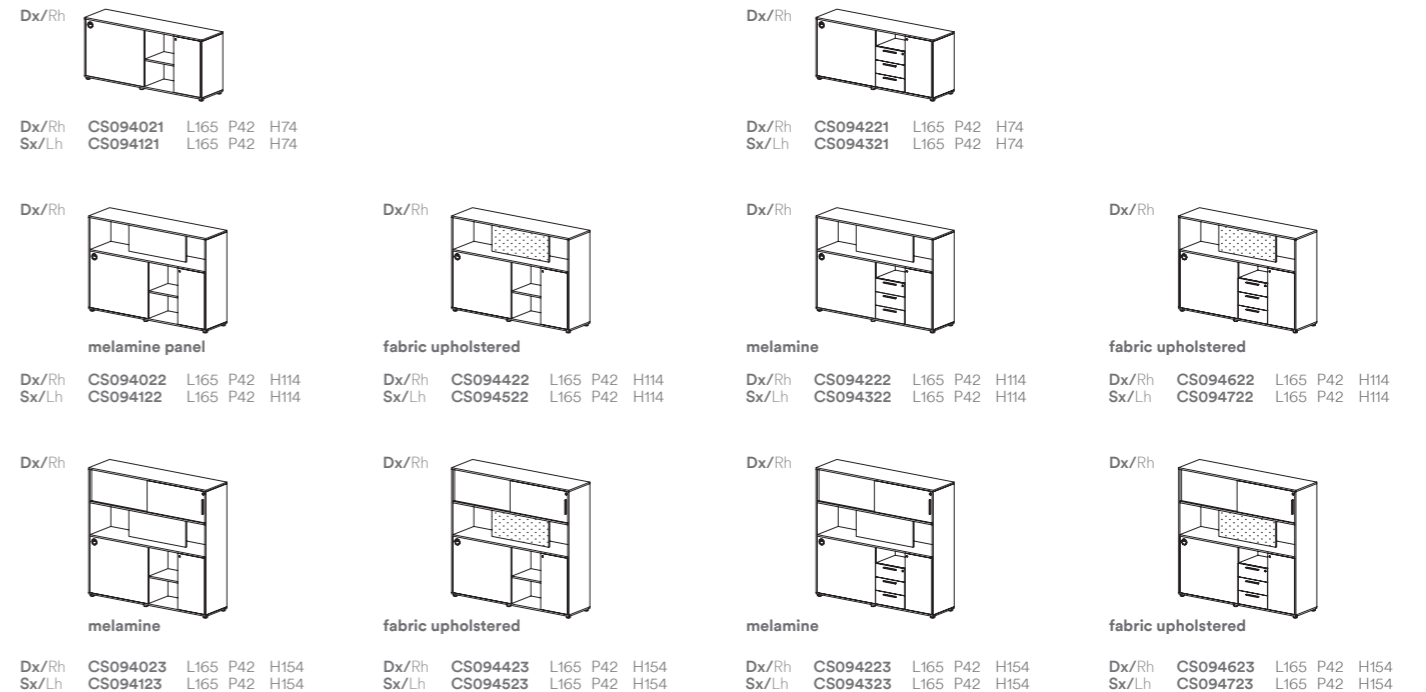



Frezza S.r.l. si riserva la facoltà di apportare modifiche o migliorie tecnico - commerciali ritenute necessarie per l'evoluzione del prodotto, senza informare il Cliente. Qualsiasi contenuto testuale o fotografico è da considerarsi puramente indicativo. Tutti i contenuti (testi, immagini, grafica, layout ecc.) presenti in questo catalogo appartengono a Frezza S.r.l.

Frezza S.r.l. reserves the right to make changes or technical and commercial improvements deemed necessary for the evolution of the product, without informing the Customer. Any textual or photographic content is to be considered purely indicative. All the contents (texts, images, graphics, layout, etc.) in this catalogue belong to Frezza S.r.l.

Frezza S.r.l. se réserve le droit d'apporter toute modification ou amélioration technique/commerciale jugée nécessaire pour l'évolution du produit, sans informer le Client. Tout contenu textuel ou photographique doit être considéré comme purement indicatif. Tous les contenus (textes, images, graphiques, mise en page, etc.) de ce catalogue appartiennent à Frezza S.r.l.

Frezza S.r.l. è certificata UNI EN ISO 9001:2015 - UNI EN ISO 14001:2015 - UNI ISO 45001:2018 - attività IAF:23. Progettazione, produzione e posa in opera di arredi per ufficio, pareti divisorie ed attrezzate e complementi di arredo (lavorazione del pannello, assemblaggio, imballo e spedizione). Frezza S.r.l. è conforme agli standard FSC-STD-40-004. Possiamo fornire prodotti certificati FSC® su richiesta.

Frezza S.r.l. is UNI EN ISO 9001:2015 - UNI EN ISO 14001:2015 - UNI ISO 45001:2018 - Activity IAF:23. Design, manufacturing and laying of office furniture, partitions and equipped walls and fittings (working panels, assembly, packaging and shipment). Frezza S.r.l. is in compliance with the standards FSC-STD-40-004. We can supply FSC® certified products on request.

Frezza S.r.l. est certifiée UNI EN ISO 9001:2015 - UNI EN ISO 14001:2015 - UNI ISO 45001:2018 - activité IAF:23. Conception, fabrication et installation de mobilier de bureau, de cloisons et de parois équipées et d'aménagements (usinage des panneaux, montage, emballage et expédition). Frezza S.r.l. est certifiée FSC-STD-40-004. Sur demande, nous pouvons fournir des produits certifiés FSC®.



Frezza S.r.l.
Via Ferret, 11/9
31020 Vidor (Treviso) Italy
Phone +39 0423 987601
Fax +39 0423 987800
www.frezza.com
e-mail: info@frezza.com
Subject to management and coordination activities on behalf of We.Do Holding S.p.A.



88010101

Printed in April 2022

